

Dell™ 4220/4320 Projector

User's Guide

Notes, Cautions, and Warnings



NOTE: A NOTE indicates important information that helps you make better use of your computer.



CAUTION: A CAUTION indicates potential damage to hardware or loss of data if instructions are not followed.



WARNING: A WARNING indicates a potential for property damage, personal injury, or death.

Information in this document is subject to change without notice.

© 2011 Dell Inc. All rights reserved.

Reproduction of these materials in any manner whatsoever without the written permission of Dell Inc. is strictly forbidden.

Trademarks used in this text: *Dell* and the *DELL* logo are trademarks of Dell Inc.; *DLP* and *DLP* logo are trademarks of TEXAS INSTRUMENTS INCORPORATED; *Microsoft* and *Windows* are either trademarks or registered trademarks of Microsoft Corporation in the United States and/or other countries.

Other trademarks and trade names may be used in this document to refer to either the entities claiming the marks and names or their products. Dell Inc. disclaims any proprietary interest in trademarks and trade names other than its own.

Model 4220/4320

March 2011 Rev. A00

Contents

1	Your Dell Projector	7
	About Your Projector	8
2	Connecting Your Projector	10
	Installing the Optional Wireless Dongle	11
	Connecting to a Computer	12
	Connecting a Computer Using a VGA Cable	12
	Monitor Loop-Through Connection Using VGA Cables	13
	Connecting a Computer Using a RS232 Cable	14
	Connecting a Computer by USB Cable	15
	Connecting a Computer Using Wireless	16
	Connecting a DVD Player	17
	Connecting a DVD Player Using an S-Video Cable	17
	Connecting a DVD Player Using a Composite Video Cable	18
	Connecting a DVD Player Using a Component Video Cable	19
	Connecting a DVD Player Using an HDMI Cable	20
	Connecting to Local Area Network	21
	To project an image and control the projector that is connected to a network through a RJ45 cable.	21
	Professional Installation Options: Installation for Driving Automatic Screen	22
	Connection With Commercial RS232 Control Box	23

3	Using Your Projector	24
	Turning Your Projector On	24
	Turning Your Projector Off	24
	Adjusting the Projected Image	25
	Raising the Projector Height	25
	Lowering the Projector Height	25
	Adjusting the Projector Zoom and Focus	26
	Adjusting Projection Image Size	27
	Using the Control Panel	31
	Using the Remote Control	33
	Installing the Remote Control Batteries	36
	Operating Range With Remote Control	37
	Using the On-Screen Display	38
	INPUT SOURCE	38
	AUTO ADJUST	39
	BRIGHTNESS/CONTRAST	40
	VIDEO MODE	40
	VOLUME	41
	AUDIO INPUT	41
	ADVANCED SETTINGS	41
	LANGUAGE	56
	HELP	56
	Wireless Networking Installation	57
	Enable Wireless on the Projector	58
	Install the Wireless Application software on Your Computer	60

Launch the Wireless Application	63
Presentation to Go (PtG) Installation	67
PtG Viewer	68
Photo Viewer	68
PtG/Photo Function Introduction	69
PtG Overview	69
Photo Overview	70
Buttons-Introduction	70
Set up PtG Converter - Lite	71
PtG Converter - Lite Application Software	72
Audio Projection Installation	73
Enable Wireless or LAN on the Projector	74
Install the Dell Wireless Application Software on Your Computer	75
Launch the Wireless Application	77
Login	77
Video Stream Installation	79
Video Stream Support Format	79
Enable Wireless or LAN on the Projector	80
Install the Dell Wireless Application Software on Your Computer	80
Launch the Wireless Application	80
Login	80
Managing the Projector From Web Management	81
Configuring the Network Setting	81
Accessing Web Management	81
Make Application Token	100

4	Troubleshooting Your Projector	101
	Guiding Signals	105
	Changing the Lamp	106
5	Specifications	108
6	Contacting Dell	115
7	Appendix: Glossary	116

Your Dell Projector

Your projector comes with all the items shown below. Ensure that you have all the items, and contact Dell™ if anything is missing.

Package Contents

Power cable



1.8 m VGA cable (VGA to VGA)



Carrying case



Remote control



CD User's Guide and Documentation AAA Batteries (2)



USB cable



About Your Projector

Top View

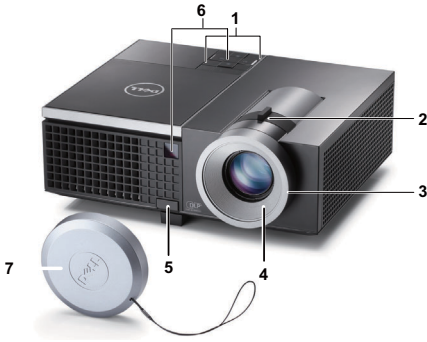

Bottom View

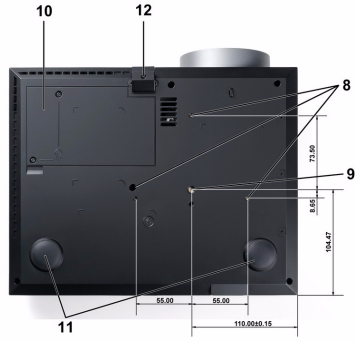

1	Control panel
2	Zoom tab
3	Focus ring
4	Lens
5	Elevator button for height adjustments
6	IR receivers
7	Lens cap
8	Mounting holes for wall mount: Screw hole M3 x 6.5 mm depth. Recommended torque <8 kgf-cm
9	Mounting hole for tripod: Insert nut 1/4"*20 UNC
10	Lamp cover
11	Tilt adjustment wheel
12	Elevator foot

CAUTION: Safety Instructions

- 1 Do not use the projector near appliances that generate a lot of heat.
- 2 Do not use the projector in areas where there is an excessive amount of dust. The dust may cause the system to fail and the projector will automatically shut down.
- 3 Ensure that the projector is mounted in a well-ventilated area.
- 4 Do not block the ventilation slots and openings on the projector.

- 5 Ensure the projector operates between ambient temperatures (5 °C to 35 °C).
- 6 Do not try to touch the ventilation outlet as it can become very hot after the projector has been turned on or immediately after it is turned off.
- 7 Do not look into the lens while the projector is on as it may cause injury to your eyes.
- 8 Do not place any objects near or in front of the projector or cover its lens while the projector is on as the heat may cause the object to melt or burn.
- 9 Do not use the wireless projector near cardiac pacemakers.
- 10 Do not use the wireless projector near medical equipment.
- 11 Do not use the wireless projector near microwave ovens.

**NOTE:**

- Do not attempt to wall mount the projector yourself. It should be installed by a qualified technician.
- Recommended Projector Ceiling Mount Kit (P/N: C3505). For more information, see the Dell Support website at support.dell.com.
- For more information, see the *Safety Information* that shipped with your projector.
- The 4220/4320 projector can only be used indoors.

2

Connecting Your Projector

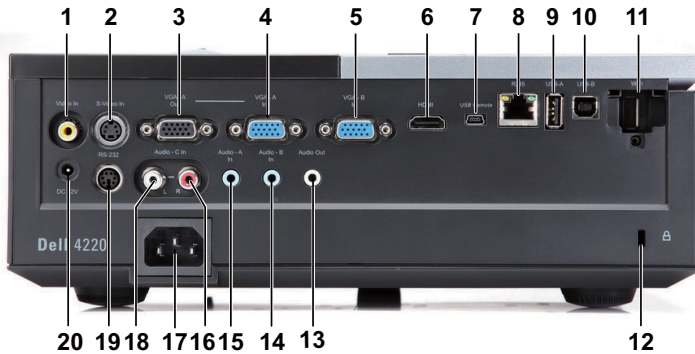

1	Composite Video connector	11	WiFi USB (Type A) connector
2	S-Video connector	12	Security cable slot
3	VGA-A output (monitor loop-through)	13	Audio output connector
4	VGA-A input (D-sub) connector	14	Audio-B input connector
5	VGA-B input (D-sub) connector	15	Audio-A input connector
6	HDMI connector	16	Audio-C right channel input connector
7	Mini USB (Mini Type B) connector for remote control	17	Power cord connector
8	RJ45 connector	18	Audio-C left-channel input connector
9	USB Type A connector for USB Viewer	19	RS232 connector
10	USB Type B connector for USB Display	20	+12 V DC out connector

 **NOTE:** Connectors are the same for 4220 and 4320 projectors.

 **CAUTION:** Before you begin any of the procedures in this section, follow the Safety Instructions as described on page 8.

Installing the Optional Wireless Dongle

Your projector must be installed with a wireless dongle if you want to use the wireless networking option. Refer to "Wireless Networking Installation" on page 57. The wireless dongle is not shipped with your 4220/4320 projector. You can purchase it on the Dell website at www.dell.com.

- 1 Unscrew and take off the wireless cover.



- 2 Plug in the wireless dongle.



- 3 Assemble the wireless cover.



Connecting to a Computer

Connecting a Computer Using a VGA Cable

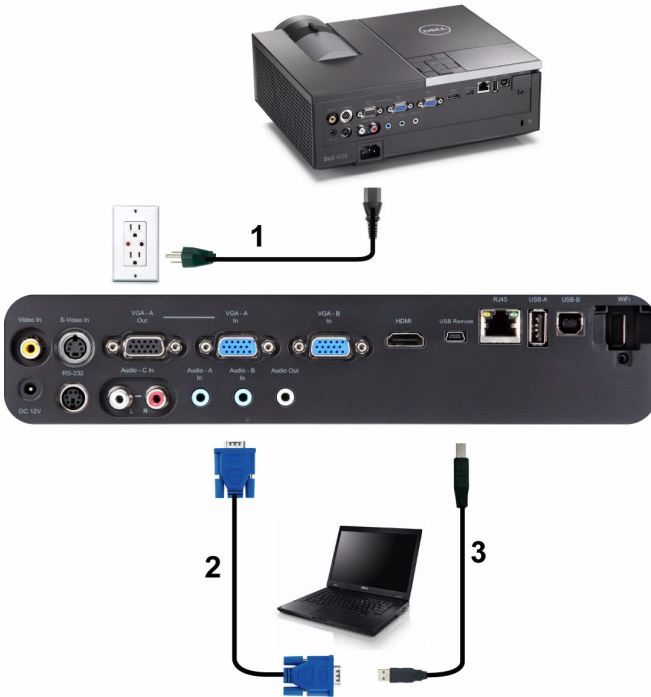

1	Power cord
2	VGA to VGA cable
3	USB-A to Mini USB-B cable

NOTE: The Mini USB cable is not shipped with your projector.

NOTE: The Mini USB cable must be connected if you want to use the Page Up and Page Down features on the remote control.

Monitor Loop-Through Connection Using VGA Cables

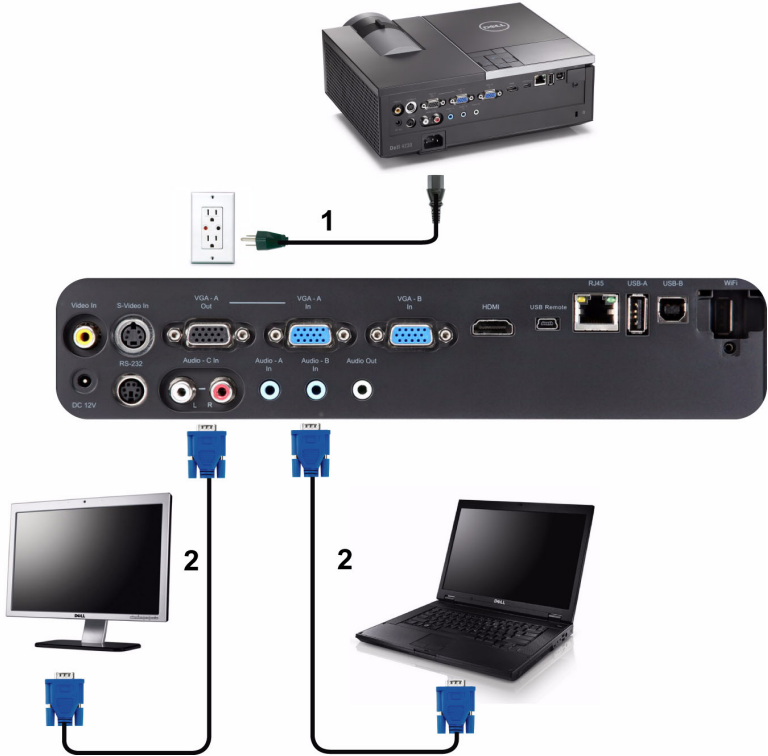

1	Power cord
2	VGA to VGA cable



NOTE: Only one VGA cable is shipped with your projector. An additional VGA cable can be purchased on the Dell website at www.dell.com.

Connecting a Computer Using a RS232 Cable



1	Power cord
2	RS232 cable



NOTE: The RS232 cable is not shipped with your projector. Consult a professional installer for the cable and RS232 remote control software.

Connecting a Computer by USB Cable



1	Power cord
2	USB-A to USB-B cable



NOTE: Plug and Play. Only one USB cable is shipped with your projector. An additional USB cable can be purchased on the Dell website at www.dell.com.

Connecting a Computer Using Wireless



NOTE: Your computer should be equipped with a wireless connector and properly configured to detect another wireless connection. Refer to your computer's documentation on how to configure a wireless connection.



NOTE: Your projector must be installed with a wireless dongle if you want to use the wireless networking. Refer to "Wireless Networking Installation" on page 57.

Connecting a DVD Player

Connecting a DVD Player Using an S-Video Cable



1	Power cord
2	S-Video cable



NOTE: The S-Video cable is not shipped with your projector. You can purchase the S-Video extension (50 ft/100 ft) cable on the Dell website at www.dell.com.

Connecting a DVD Player Using a Composite Video Cable



1	Power cord
2	Composite Video cable



NOTE: The Composite Video cable is not shipped with your projector. You can purchase the Composite Video Extension (50 ft/100 ft) cable on the Dell website at www.dell.com.

Connecting a DVD Player Using a Component Video Cable

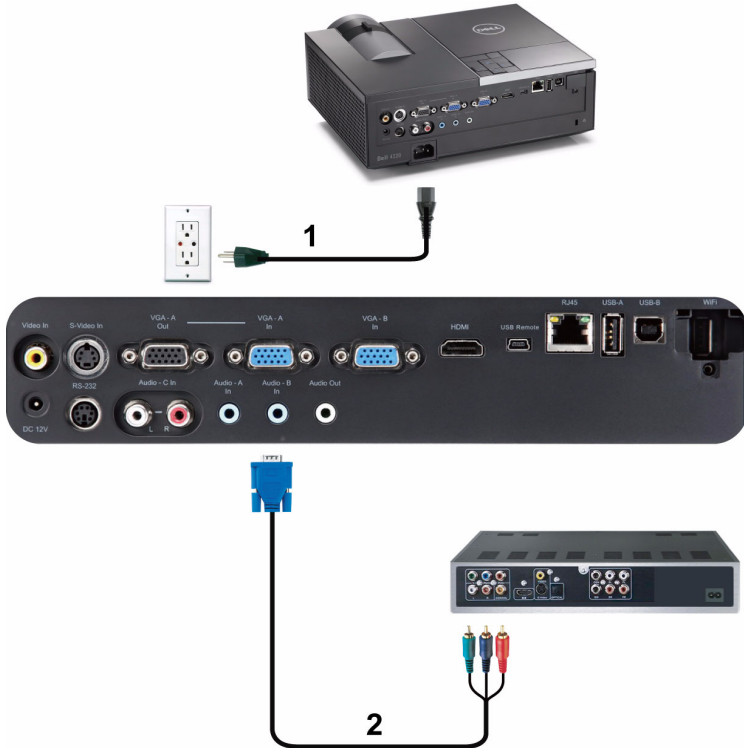

1	Power cord
2	VGA to Component Video cable



NOTE: The VGA to Component Video cable is not shipped with your projector. You can purchase the VGA to Component Video Extension (50 ft/100 ft) cable on the Dell website at www.dell.com.

Connecting a DVD Player Using an HDMI Cable



1	Power cord
2	HDMI cable



NOTE: The HDMI cable is not shipped with your projector. You can purchase the HDMI cable on the Dell website at www.dell.com.

Connecting to Local Area Network

To project an image and control the projector that is connected to a network through a RJ45 cable.

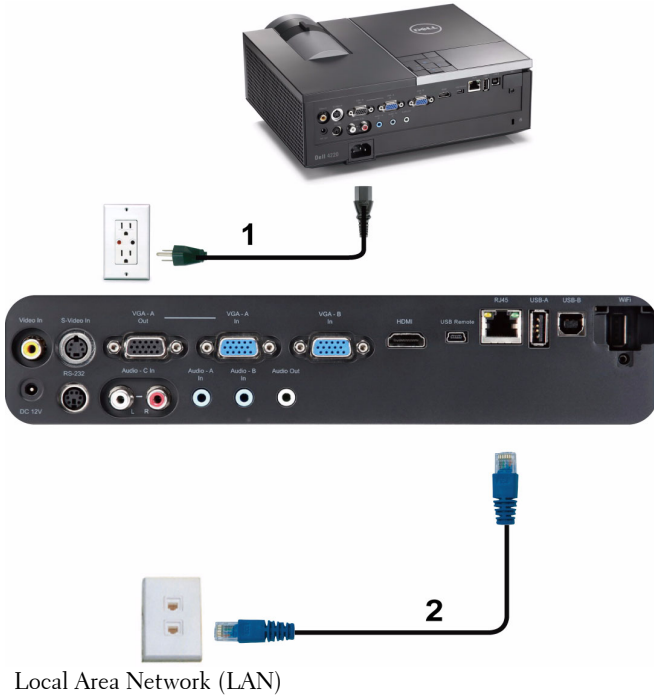

1	Power cord
2	RJ45 cable



NOTE: The RJ45 cable is not shipped with your projector. You can purchase the RJ45 cable on the Dell website at www.dell.com.

Professional Installation Options: Installation for Driving Automatic Screen

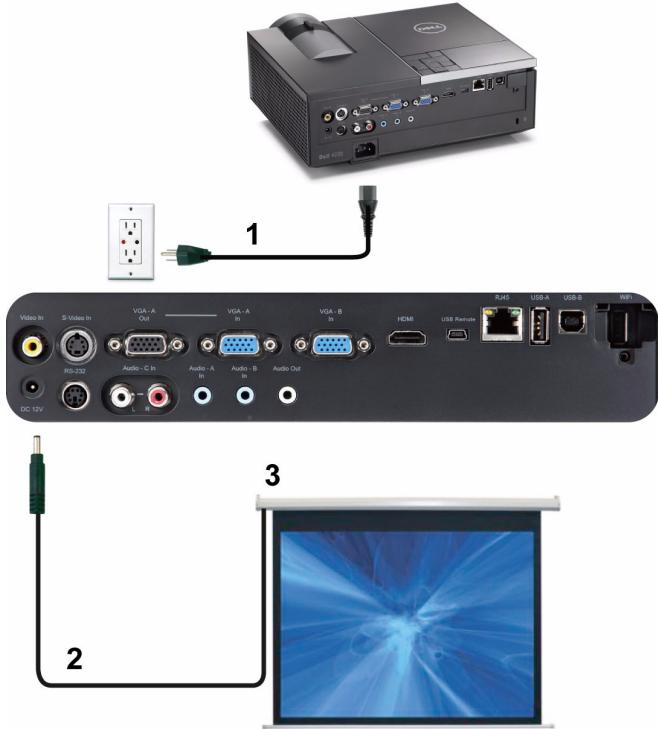

1	Power cord
2	12 V DC Plug
3	Motorized projection screen

NOTE: Use a 12 V DC plug in, 1.7 mm (ID) x 4.00 mm (OD) x 9.5 mm (shaft), to connect the automatic screen to the projector.

12 V DC Plug

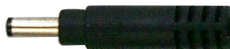

Connection With Commercial RS232 Control Box



1	Power cord
2	RS232 cable
3	Commercial RS232 control box



NOTE: The RS232 cable is not shipped with your projector. Consult a professional technician to obtain the cable.

Using Your Projector

Turning Your Projector On

 **NOTE:** Turn on the projector before you turn on the source (computer, DVD player, etc.). The **Power** button light blinks blue until pressed.

- 1 Remove the lens cap.
- 2 Connect the power cord and appropriate signal cables to the projector. For information about connecting the projector, see "Connecting Your Projector" on page 10.
- 3 Press the **Power** button (see "Using the Control Panel" on page 31 to locate the **Power** button).
- 4 Turn on your source (computer, DVD player, etc.)
- 5 Connect your source to the projector using the appropriate cable. See "Connecting Your Projector" on page 10 for instructions to connect your source to the projector.
- 6 By default, the input source of the projector is set to VGA-A. Change the input source of the projector if necessary.
- 7 If you have multiple sources connected to the projector, press the **Source** button on the remote control or control panel to select the desired source. See "Using the Control Panel" on page 31 and "Using the Remote Control" on page 33 to locate the **Source** button.

Turning Your Projector Off

 **CAUTION:** Unplug the projector after properly shutting down as explained in the following procedure.

- 1 Press the **Power** button. Follow the instruction displayed on screen to properly turn off the projector.

 **NOTE:** The "**Press Power Button to Turn off Projector**" message will appear on the screen. The message disappears after 5 seconds or you can press the **Menu** button to clear it.

- 2 Press the **Power** button again. The cooling fans continue to operate for 120 seconds.

3 To power off the projector quickly, press the Power button and hold for 1 second while the projector's cooling fans are still running.

NOTE: Before you turn on the projector again, wait for 60 seconds to allow the internal temperature to stabilize.

4 Disconnect the power cord from the electrical outlet and the projector.

Adjusting the Projected Image

Raising the Projector Height

1 Press the Elevator button.

2 Raise the projector to the desired display angle, and then release the button to lock the elevator foot into position.

3 Use the tilt adjustment wheel to fine-tune the display angle.

Lowering the Projector Height

1 Press the Elevator button.

2 Lower the projector, then release the button to lock the elevator foot into position.



1	Elevator button
2	Elevator foot (Angle of tilt: 0 to 9,5 degrees)
3	Tilt adjustment wheel

Adjusting the Projector Zoom and Focus

CAUTION: To avoid damaging the projector, ensure that the zoom lens and elevator foot are fully retracted before moving the projector or placing the projector in its carrying case.

- 1 Rotate the zoom tab to zoom in and out.
- 2 Rotate the focus tab until the image is clear. The projector focuses at distances ranging between 3.94 ft to 32.81 ft (1.2 m to 10 m).



1	Zoom tab
2	Focus ring

Adjusting Projection Image Size

4220

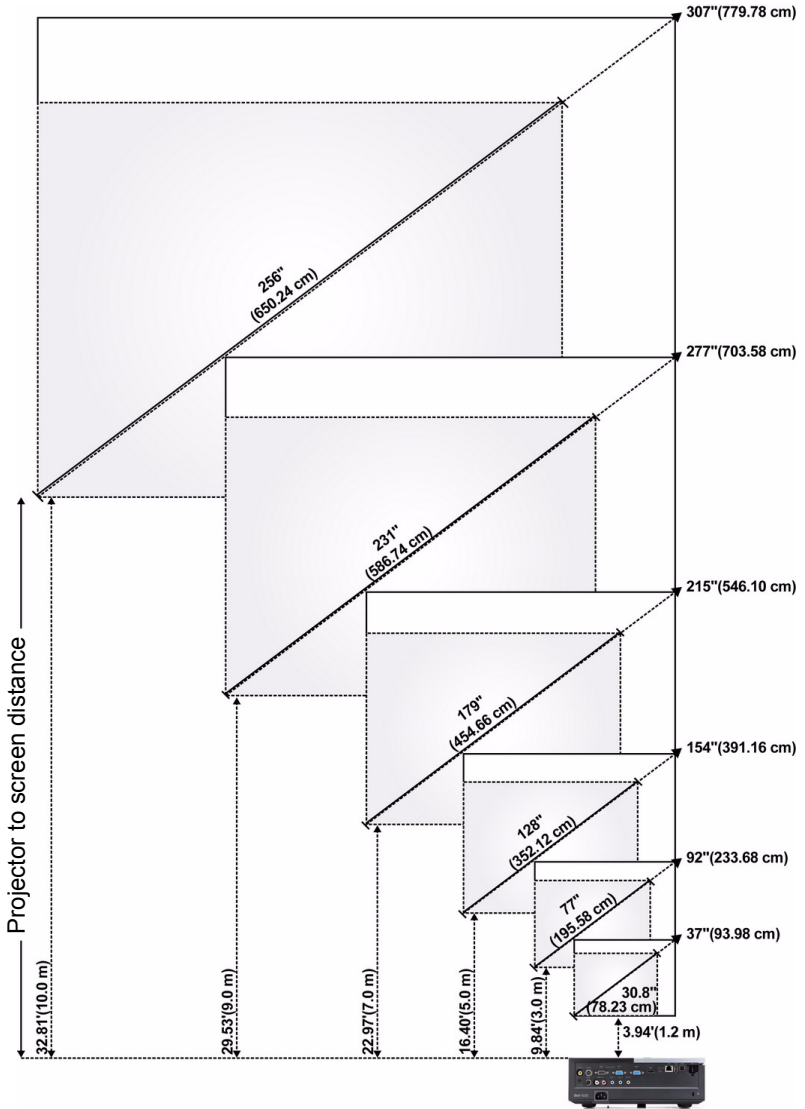

4320

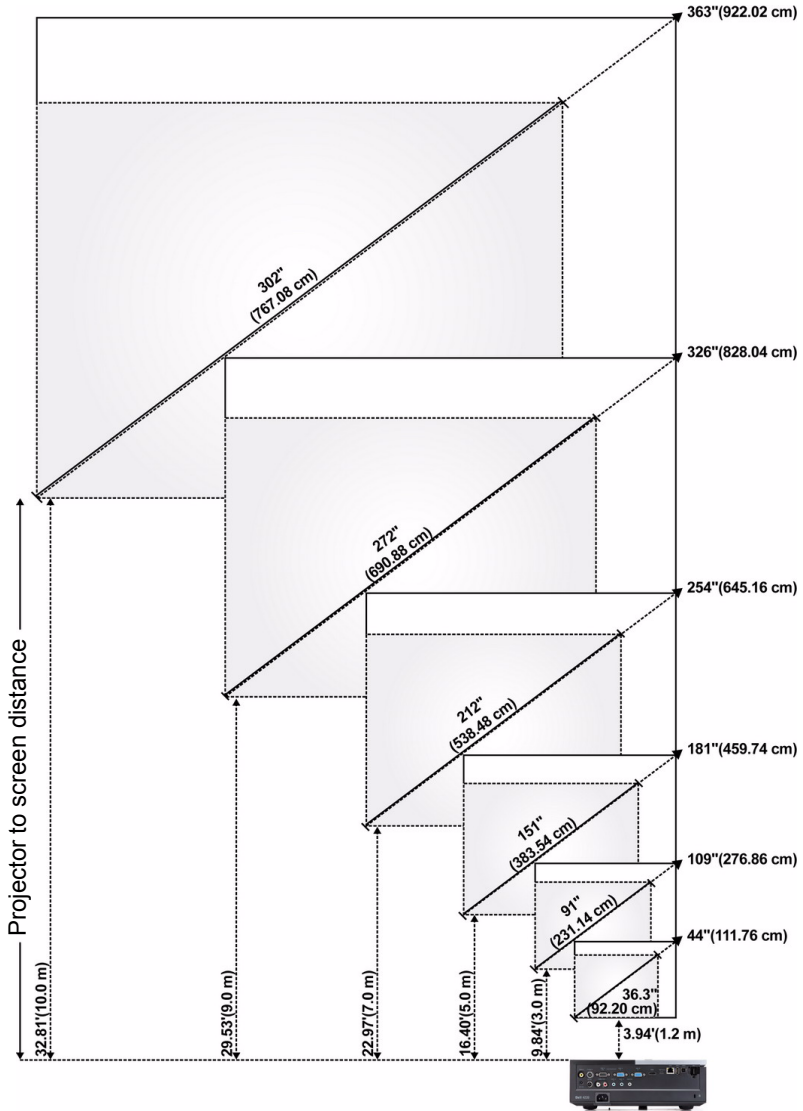

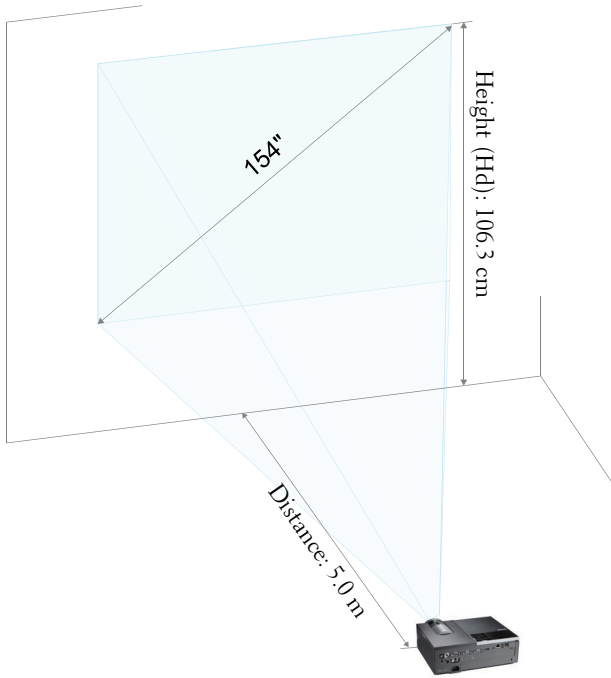

4220

Screen (Diagonal)	Max.	37" (93.98 cm)	92" (233.68 cm)	154" (391.16 cm)	215" (546.10 cm)	277" (703.58 cm)	307" (779.78 cm)
	Min.	30.8" (78.23 cm)	77" (195.58 cm)	128" (325.12 cm)	179" (454.66 cm)	231" (586.74 cm)	256" (650.24 cm)
Screen Size	Max. (WxH)	29.53" X 22.05"	74.02" X 55.51"	123.23" X 92.13"	172.44" X 129.13"	221.65" X 166.14"	246.06" X 184.65"
		(75 cm X 56 cm)	(188 cm X 141 cm)	(313 cm X 234 cm)	(438 cm X 328 cm)	(563 cm X 422 cm)	(625 cm X 469 cm)
	Min. (WxH)	24.80" X 18.50"	61.42" X 46.06"	102.36" X 76.77"	143.70" X 107.48"	184.65" X 138.58"	205.12" X 153.94"
		(63 cm X 47 cm)	(156 cm X 117 cm)	(260 cm X 195 cm)	(365 cm X 273 cm)	(469 cm X 352 cm)	(521 cm X 391 cm)
Hd	Max.	25.59" (65 cm)	63.78" (162 cm)	106.30" (270 cm)	148.43" (377 cm)	190.94" (485 cm)	212.20" (539 cm)
	Min.	21.26" (54 cm)	53.15" (135 cm)	88.58" (225 cm)	123.62" (314 cm)	159.06" (404 cm)	176.77" (449 cm)
Distance		3.94' (1.2 m)	9.84' (3.0 m)	16.40' (5.0 m)	22.97' (7.0 m)	29.53' (9.0 m)	32.81' (10 m)
* This graph is for user reference only.							

4320

Screen (Diagonal)	Max.	44" (111.76 cm)	109" (276.86 cm)	181" (459.74 cm)	254" (645.16 cm)	326" (828.04 cm)	363" (922.02 cm)
	Min.	36.3" (92.20 cm)	91" (231.14 cm)	151" (383.54 cm)	212" (538.48 cm)	272" (690.88 cm)	302" (767.08 cm)
Screen Size	Max. (WxH)	37.01" X 23.23"	92.13" X 57.48"	153.94" X 96.06"	215.35" X 134.65"	276.77" X 172.83"	307.48" X 192.13"
		(94 cm X 59 cm)	(234 cm X 146 cm)	(391 cm X 244 cm)	(547 cm X 342 cm)	(703 cm X 439 cm)	(781 cm X 488 cm)
	Min. (WxH)	30.71" X 19.29"	76.77" X 48.03"	128.35" X 79.92"	179.53" X 112.20"	230.71" X 144.09"	256.30" X 160.24"
		(78 cm X 49 cm)	(195 cm X 122 cm)	(326 cm X 203 cm)	(456 cm X 285 cm)	(586 cm X 366 cm)	(651 cm X 407 cm)
Hd	Max.	25.98" (66 cm)	64.96" (165 cm)	107.87" (274 cm)	151.18" (384 cm)	194.49" (494 cm)	216.14" (549 cm)
	Min.	21.65" (55 cm)	53.94" (137 cm)	90.16" (229 cm)	125.98" (320 cm)	162.20" (412 cm)	179.92" (457 cm)
Distance		3.94' (1.2 m)	9.84' (3.0 m)	16.40' (5.0 m)	22.97' (7.0 m)	29.53' (9.0 m)	32.81' (10 m)
* This graph is for user reference only.							

Using the Control Panel

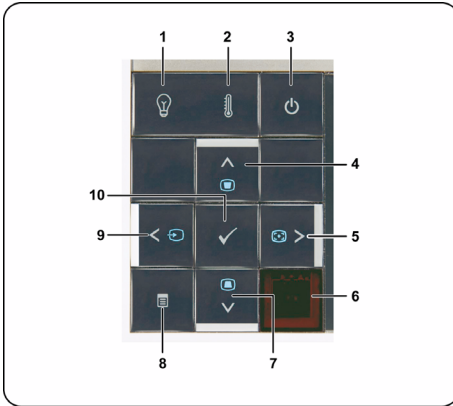

1 LAMP warning light

If the LAMP amber indicator is on or blinking, one of the following problems could be occurring:

- Lamp is reaching its end of usable life
- Lamp module is not properly installed
- Lamp driver failure
- Color wheel failure

For more information, see "Troubleshooting Your Projector" on page 101 and "Guiding Signals" on page 105.

2 TEMP warning light







If the TEMP amber indicator is on or blinking, one of the following problems could be occurring:

- Internal temperature of the projector is too high
- Color wheel failure

For more information, see "Troubleshooting Your Projector" on page 101 and "Guiding Signals" on page 105.





3 Power









Turns the projector on or off. For more information, see "Turning Your Projector On" on page 24 and "Turning Your Projector Off" on page 24.





4	Up  / Keystone adjustment	<p>Press to navigate through the On-Screen Display (OSD) Menu items.</p> <p>Press to adjust image distortion caused by tilting the projector (+40/-35 degrees).</p>
5	Right  / Auto Adjust	<p>Press to navigate through the On-Screen Display (OSD) Menu items.</p> <p>Press to synchronize the projector to the input source.</p> <p> NOTE: Auto Adjust does not operate if the on-screen display (OSD) is displayed.</p>
6	IR Receiver	<p>Point the remote control towards the IR receiver and press a button.</p>
7	Down  / Keystone adjustment	<p>Press to navigate through the On-Screen Display (OSD) Menu items.</p> <p>Press to adjust image distortion caused by tilting the projector (+40/-35 degrees).</p>
8	Menu 	<p>Press to activate the OSD. Use the directional keys and the Menu button to navigate through the OSD.</p>
9	Left  / Source	<p>Press to navigate through the On-Screen Display (OSD) Menu items.</p> <p>Press to toggle through Analog RGB, Composite, Component (YPbPr via VGA), HDMI, and S-Video sources when multiple sources are connected to the projector.</p>
10	Enter 	<p>Press to confirm the selection item.</p>

Using the Remote Control



1	Power 	Turns the projector on or off. For more information, see "Turning Your Projector On" on page 24 and "Turning Your Projector Off" on page 24.
2	Enter 	Press to confirm the selection.
3	Right 	Press to navigate through the On-Screen Display (OSD) Menu items.
4	Down 	Press to navigate through the On-Screen Display (OSD) Menu items.

5	Laser 	Point the remote control at the screen, press and hold the laser button to activate the laser light.  WARNING: Do not look at the laser point when it is active. Avoid directing the laser light on your eyes.
6	Aspect Ratio	Press to change the aspect ratio of a displayed image.
7	Keystone adjustment 	Press to adjust image distortion caused by tilting the projector (+40/-35 degrees).
8	Page up 	Press to move to the previous page.  NOTE: The Mini USB cable must be connected if you want to use the Page Up feature.
9	Page down 	Press to move to the next page.  NOTE: The Mini USB cable must be connected if you want to use the Page Down feature.
10	Keystone adjustment 	Press to adjust image distortion caused by tilting the projector (+40/-35 degrees).
11	S-Video	Press to choose S-Video source.
12	Video	Press to choose Composite Video source.
13	Video mode	The projector has preset configurations that are optimized for displaying data (presentation slides) or video (movies, games, etc.). Press the Video Mode button to toggle between Presentation mode , Bright mode , Movie mode , sRGB , or Custom mode . Pressing the Video Mode button once will show the current display mode. Pressing the Video Mode button again will switch between modes.
14	Blank screen	Press to hide/unhide the image.
15	Up 	Press to navigate through the On-Screen Display (OSD) Menu items.

16	Left 	Press to navigate through the On-Screen Display (OSD) Menu items.
17	Menu 	Press to activate the OSD.
18	Mute 	Press to mute or un-mute the projector speaker.
19	Zoom +	Press to increase the image.
20	Zoom -	Press to decrease the image.
21	Volume up 	Press to increase the volume.
22	Volume down 	Press to decrease the volume.
23	Freeze	Press to pause the screen image, then press "Freeze" again to unfreeze image.
24	VGA	Press to choose VGA source.
25	Source	Press to switch between Analog RGB, Composite, Component (YPbPr, via VGA), HDMI, and S-Video source.
26	Auto Adjust	Press to synchronize the projector with the input source. Auto Adjust does not operate if the OSD is displayed.

Installing the Remote Control Batteries

 **NOTE:** Remove the batteries from the remote control when not in use.

1 Press the tab to lift the battery compartment cover.

1



2 Check the polarity (+/-) marking on the batteries.

2



3 Insert the batteries and align their polarity correctly according to the marking in the battery compartment.

3



 **NOTE:** Avoid mixing different types of batteries or using new and old batteries together.

4 Slip the battery cover back.

4





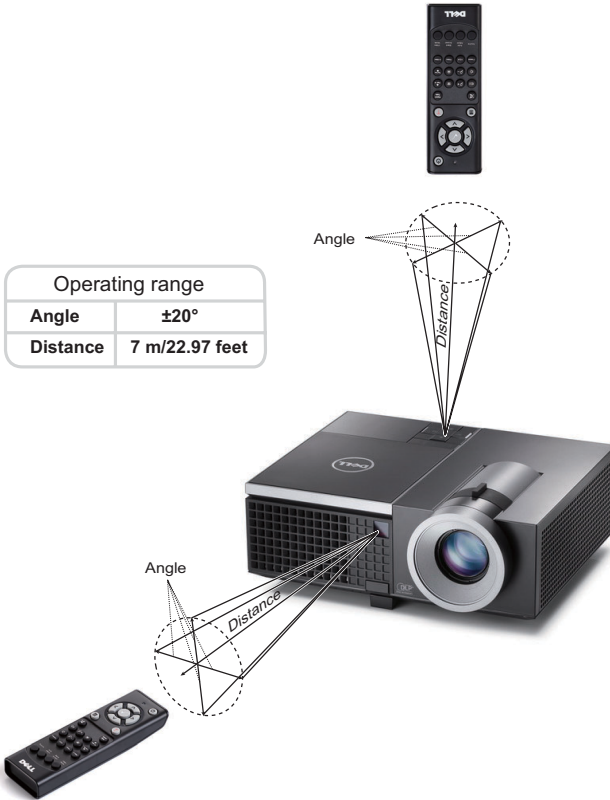







Operating Range With Remote Control



 **NOTE:** Actual operating range may slightly differ from the diagram. Weak batteries will also prevent the remote control from properly operating the projector.

Using the On-Screen Display

- The projector has a multi-language On-Screen Display (OSD) Menu that can be displayed with or without an input source.
- Press the Menu button on the control panel or the remote control to enter the Main Menu.
- To navigate through the tabs in the Main Menu, press the  or  buttons on your projector's control panel or remote control.
- To select a submenu, press the  or  button on your projector's control panel or remote control.
- To select an option, press the  or  buttons on your projector's control panel or remote control. When an item is selected, the color changes to dark blue.
- Use the  or  buttons on the control panel or remote control to adjust the settings.
- To go back to the Main Menu, press the  button on the control panel or the remote control.
- To exit the OSD, press the Menu button directly on the control panel or the remote control.

 **NOTE:** OSD structure and set are the same for the 4220 and 4320 models.

INPUT SOURCE

The Input Source menu allows you to select your projector's input source.

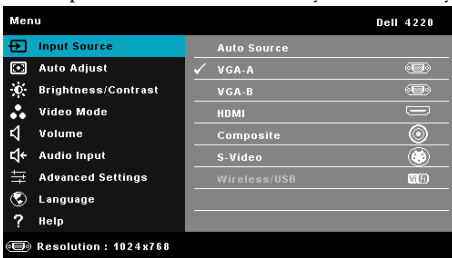



VGA-A—Press  to detect a VGA-A signal.

VGA-B—Press  to detect a VGA-B signal.

HDMI—Press  to detect a HDMI signal.

COMPOSITE—Press  to detect a Composite Video signal.

S-VIDEO—Press  to detect a S-Video signal.

WIRELESS/USB—Press  to activate the Input Source Wireless/USB menu.



NOTE: The Wireless/USB can be used after the "Wireless and LAN" option is turned on.

INPUT SOURCE WIRELESS/USB

The Input Source Wireless/USB menu allows you to activate the Wireless Display, USB Display, and USB Viewer.

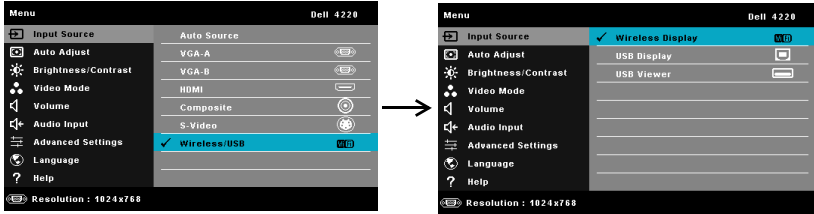

WIRELESS DISPLAY—Press to access the projector's Wireless Guide screen. See "Wireless Guide screen" on page 59.

USB DISPLAY—Allows you to display the computer/laptop screen to your projector via the USB cable.

USB VIEWER—Allows you to display photo and PPT files from your USB flash. See "Presentation to Go (PtG) Installation" on page 67.

AUTO ADJUST

Auto Adjust automatically adjusts the projector's Horizontal, Vertical, Frequency, and Tracking in PC mode.



BRIGHTNESS/CONTRAST

The Brightness/Contrast menu allows you to adjust the brightness/contrast settings of your projector.

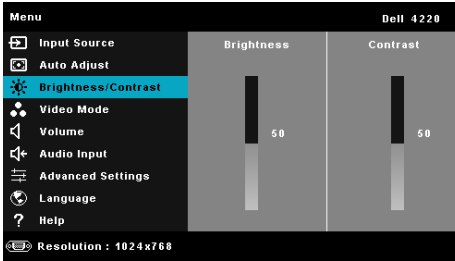

BRIGHTNESS—Use and to adjust the brightness of the image.

CONTRAST—Use and to adjust the display contrast.



NOTE: If you adjust the settings for **Brightness** and **Contrast** the projector automatically switch to **Custom mode**.

VIDEO MODE

The Video Mode menu allows you to optimize the display image: **Presentation**, **Bright**, **Movie**, **sRGB** (provides more accurate color representation), and **Custom** (set your preferred settings).

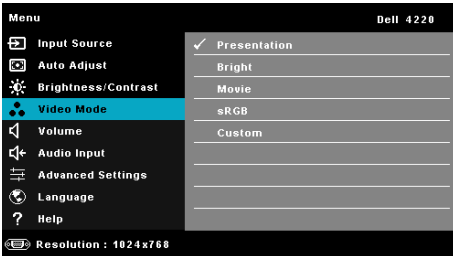

VOLUME

The Volume menu allows you adjust the volume settings of your projector.

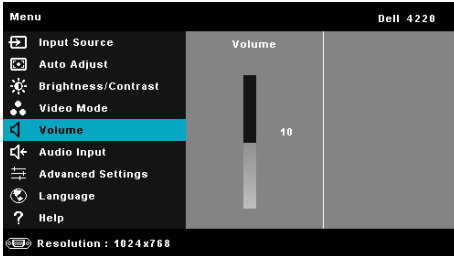

VOLUME—Press to increase the volume and to decrease the volume.

AUDIO INPUT

The Audio Input menu allows you to select your audio input source. The options are: Audio-A, Audio-B, Audio-C, HDMI, and Wireless/LAN.

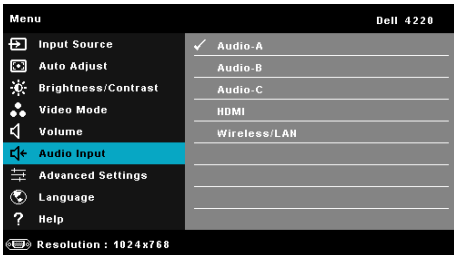

ADVANCED SETTINGS

The Advanced Settings menu allows you to change settings for Image, Display, Projector, LAN, Wireless, Menu, Power, and Information.

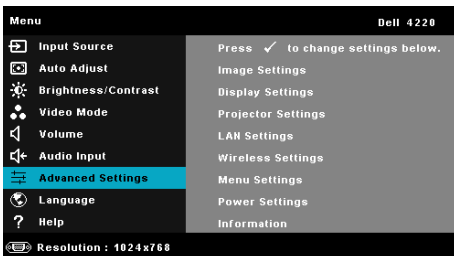

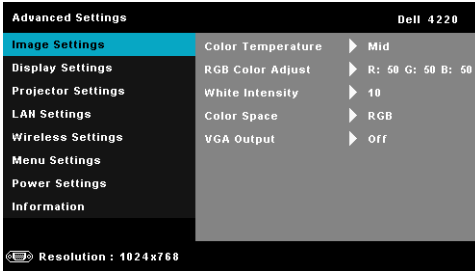

IMAGE SETTINGS (IN PC MODE)—Select and press  to activate image settings. The image settings menu provides the following options:



COLOR TEMPERATURE—Allows you to adjust the color temperature. The screen appears cooler at higher color temperatures and warmer at lower color temperatures. When you adjust the values in the **Color Adjust** menu, the Custom mode is activated. The values are saved in the Custom mode.

RGB COLOR ADJUST—Allows you to manually adjust the colors red, green, and blue.

WHITE INTENSITY—Press  and use  and  to display white intensity.

COLOR SPACE—Allows you to select the color space. The options are: RGB, YCbCr, and YPbPr.

VGA OUTPUT—Select On or Off the VGA output function at projector standby status. Default is Off.



NOTE: If you adjust the settings for **Color Temperature**, **RGB Color Adjust**, and **White Intensity** the projector automatically switch to **Custom mode**.

IMAGE SETTINGS (IN VIDEO MODE)—Select and press  to activate image settings. The image settings menu provides the following options:

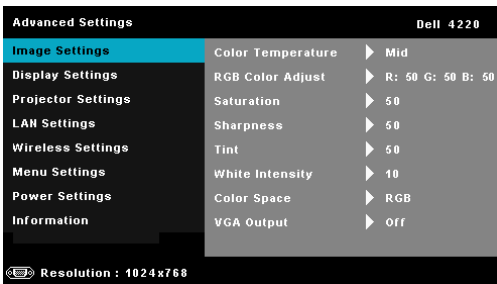

COLOR TEMPERATURE—Allows you to adjust the color temperature. The screen appears cooler at higher color temperatures and warmer at lower color temperatures. When you adjust the values in the **Color Adjust** menu, the Custom mode is activated. The values are saved in the Custom mode.

RGB COLOR ADJUST—Allows you to manually adjust the colors red, green, and blue.

SATURATION—Allows you to adjust the video source from black and white to fully saturated color. Press to increase the amount of color in the image and to decrease the amount of color in the image.

SHARPNESS—Press to increase the sharpness and to decrease the sharpness.

TINT—Press to increase the amount of green in the image and to decrease the amount of green in the image (available for NTSC only).

WHITE INTENSITY—Press and use and to display white intensity.

COLOR SPACE—Allows you to select the color space. The options are: RGB, YCbCr, and YPbPr.

VGA OUTPUT—Select On or Off the VGA output function at projector standby status. Default is Off.



NOTE:

- 1 If you adjust the settings for **Color Temperature, RGB Color Adjust, Saturation, Sharpness, Tint, and White Intensity** the projector automatically switch to **Custom mode**.
- 2 **Saturation, Sharpness, and Tint** are only available when the input source is from Composite or S-Video.

IMAGE SETTINGS (NO INPUT SOURCE)—Select and press to activate image settings. The image settings menu provides the following options:

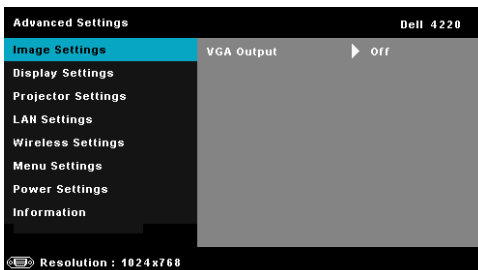

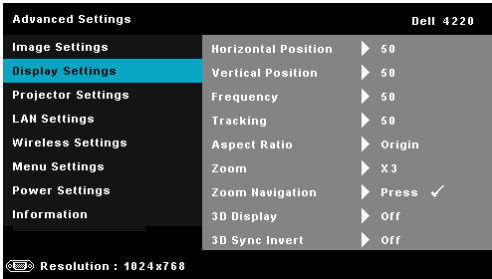

VGA OUTPUT—Select On or Off the VGA output function at projector standby status. Default is Off.

DISPLAY SETTINGS (IN PC MODE)—Select and press  to activate display settings. The display settings menu provides the following options:



HORIZONTAL POSITION—Press  to move the image right and  to move the image left.



VERTICAL POSITION—Press  to move the image up and  to move the image down.

FREQUENCY—Allows you to change the display data clock frequency to match the frequency of your computer’s graphics card. If you see a vertical flickering wave, use the Frequency control to minimize the bars. This is a coarse adjustment.



TRACKING—Synchronize the phase of the display signal with the graphic card. If you experience an unstable or flickering image, use Tracking to correct it. This is a fine adjustment.

ASPECT RATIO—Allows you to select the aspect ratio to adjust how the image appears. Options are: Origin, 16:9, and 4:3.

- Origin — Select Origin to maintain the aspect ratio of the image projector according to the input source.
- 16:9 — The input source scales to fit the width of the screen to project a 16:9 screen image.
- 4:3 — The input source scales to fit the screen and projects a 4:3 image.

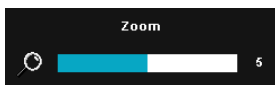



Zoom—Press  and  to zoom and view the image.



Adjust the image scale by pressing  or  and press  to view on your remote control only.



Zoom Navigation—Press  to activate the Zoom Navigation menu.

Use     to navigate the projection screen.

3D DISPLAY—Select On to start the 3D display function (default is Off).



NOTE:

1. When you want to create a 3D experience, you will need a few other components including:
 - a Computer/Laptop with a 120 Hz signal output quad-buffered graphics card.
 - b "Active" 3D glasses with DLP Link™.
 - c 3D content. See "Note 4".
 - d 3D Player. (Example: Stereoscopic Player...)
2. Enable the 3D function when it satisfies any of the below-mentioned conditions:
 - a Computer/Laptop with a graphics card, capable of outputting a 120 Hz signal via VGA or HDMI cable.
 - b Input a suite of 3D content via Video and S-Video.
3. "3D Display" selection will only be enabled in the "Display Settings of the Advanced Settings" menu when the projector detects either of the inputs mentioned above.
4. 3D support and refresh rate are as below:
 - a VGA/HDMI 1280 x 720 120 Hz, 1024 x 768 120 Hz, and 800 x 600 120 Hz
 - b Composite/S-Video 60 Hz
 - c Component 480i
5. The recommended VGA signal for laptop is Single-mode output (Dual mode is not recommended).

3D SYNC INVERT—If you see a discrete or overlapping image while wearing DLP 3D goggles, you may need to execute 'Invert' to get best match of left/right image sequence to get the correct image. (For DLP 3D goggles)

DISPLAY SETTINGS (IN VIDEO MODE)—Select and press to activate display settings. The display settings menu provides the following options:

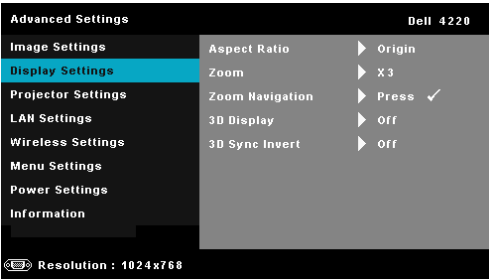

ASPECT RATIO—Allows you to select the aspect ratio to adjust how the image appears. Options are: Origin, 16:9, and 4:3.

- Origin — Select Origin to maintain the aspect ratio of image projector according to the input source.
- 16:9 — The input source scales to fit the width of the screen to project a 16:9 screen image.
- 4:3 — The input source scales to fit the screen and projects a 4:3 image.

ZOOM—Press and to zoom and view the image.

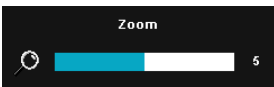

Adjust the image scale by pressing or and press to view on your remote control only.



ZOOM NAVIGATION—Press to activate the Zoom Navigation menu.

Use to navigate the projection screen.

3D DISPLAY—Select On to start the 3D display function (default is Off).

 **NOTE:**

1. When you want to create a 3D experience, you will need a few other components including:
 - a Computer/Laptop with a 120 Hz signal output quad-buffered graphics card.
 - b "Active" 3D glasses with DLP Link™.
 - c 3D content. See "Note 4".
 - d 3D Player. (Example: Stereoscopic Player...)

2. Enable the 3D function when it satisfies any of the below-mentioned conditions:
 - a Computer/Laptop with a graphics card, capable of outputting a 120 Hz signal via VGA or HDMI cable.
 - b Input a suite of 3D content via Video and S-Video.
3. "3D Display" selection will only be enabled in the "Display Settings of the Advanced Settings" menu when the projector detects either of the inputs mentioned above.
4. 3D support and refresh rate are as below:
 - a VGA/HDMI 1280 x 720 120 Hz, 1024 x 768 120 Hz, and 800 x 600 120 Hz
 - b Composite/S-Video 60 Hz
 - c Component 480i
5. The recommended VGA signal for laptop is Single-mode output (Dual mode is not recommended).

3D SYNC INVERT—If you see a discrete or overlapping image while wearing DLP 3D goggles, you may need to execute 'Invert' to get best match of left/right image sequence to get the correct image. (For DLP 3D goggles)

PROJECTOR SETTINGS—Select and press  to activate projector settings. The projector settings menu provides the following options:

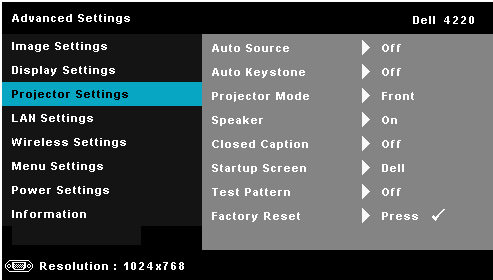

AUTO SOURCE—Select **Off** (the default) to lock the current input signal. If you press the **Source** button when the **Auto Source** mode is set to **Off**, you can manually select the input signal. Select **On** to auto detect the available input signals. If you press the **Source** button when the projector is on, it automatically finds the next available input signal.

AUTO KEYSTONE—Select **On** to automatically adjust image distortion caused by tilting the projector.

PROJECTOR MODE—Allows you to select the projector mode, depending upon how the projector is mounted.

- Rear Projection-Desktop — The projector reverses the image so that you can project from behind a translucent screen.
- Rear Projection-Ceiling Mount — The projector reverses and turns the image upside down. You can project from behind a translucent screen with a ceiling-mounted projection.
- Front Projection-Desktop — This is the default option.
- Front Projection-Ceiling Mount — The projector turns the image upside down for ceiling-mounted projection.

SPEAKER—Select **On** to enable the speaker. Select **Off** to the disable speaker.

CLOSED CAPTION—Select **On** to enable close caption and activate the closed caption menu. Select appropriate closed caption options: CC1, CC2, CC3, and CC4.





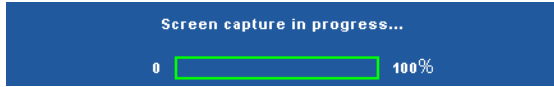

NOTE: Closed caption option is available for NTSC only.

STARTUP SCREEN—Default is Dell logo as wallpaper. You can also select Capture Screen option to capture the screen display. The following message appears on the screen.



 **NOTE:** To capture a full image, ensure that the input signal connected to the projector is at 1024 x 768 resolution.

TEST PATTERN—Test Pattern is used to test focus and resolution.

You can enable or disable the **Test Pattern** by selecting **Off**, **1**, or **2**. You can also invoke the Test Pattern 1 by pressing and holding down  and  buttons on the control panel simultaneously for 2 seconds. You can also invoke the test pattern 2 by pressing and holding down  and  buttons on the control panel simultaneously for 2 seconds.

Test Pattern 1:

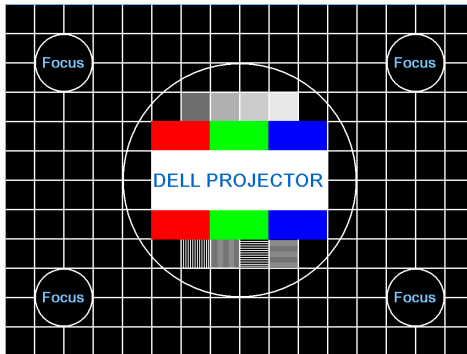

Test Pattern 2:



FACTORY RESET—Select and press  to reset all settings to its factory default. The below warning message appears:





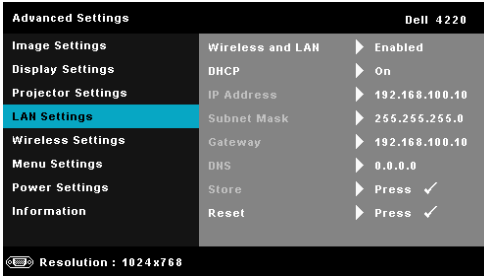

Reset items include both computer sources and Video source settings.

LAN SETTINGS—Select and press  to activate LAN settings. The LAN settings menu provides the following options:



WIRELESS AND LAN—Select **Enabled** to activate the Wireless and LAN function.

DHCP—If a DHCP server exists in the network to which the projector is connected, the IP address will automatically be acquired when you select DHCP On. If DHCP is Off, manually set the IP Address, Subnet Mask, and Gateway. Use  and  to select the number of IP address, Subnet Mask, and Gateway. Key in enter to confirm each number and then use  and  to set the next item.

IP ADDRESS—Automatically or manually assigns the IP address to the projector connected to the network.







SUBNET MASK—Configure the Subnet Mask of the network connection.



GATEWAY—Check the Gateway address with your network/system administrator if you configure it manually.

DNS—Check the DNS Server IP address with your network/system administrator if you configure it manually.

STORE—Press  to save the changes made in network configuration settings.

 **NOTE:**

1. Use  and  buttons to select IP Address, Subnet Mask, Gateway, DNS, and Store.
2. Press the  button to enter IP Address, Subnet Mask, Gateway, or DNS to set the value. (The selected option is highlighted in blue)
 - a Use  and  buttons to select the option.
 - b Use  and  buttons to set the value.

- c After the setup is complete, press the  button to exit.
3. After the IP Address, Subnet Mask, Gateway, and DNS is set up, select **Store** and press  button to store the settings.
4. If you select **Store** without pressing the **Enter** button, the system will keep the original settings.

RESET—Press  to reset network configuration.

WIRELESS SETTINGS—Select and press  to activate wireless settings. The wireless settings menu provides the following options:

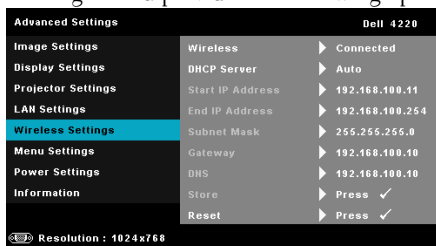

WIRELESS—Default option is **Connected**. Select **Disconnected** to disable the wireless connection.

 **NOTE:** It is recommended to use the default settings for **Wireless Connect**.

DHCP SERVER—Allows you to enable DHCP server of the wireless.

START IP ADDRESS—Automatically or manually assigns the Start IP address of the DHCP server to the projector connected to the wireless.

END IP ADDRESS—Automatically or manually assigns the End IP address of the DHCP server to the projector connected to the wireless.



SUBNET MASK—Configure the Subnet Mask of the wireless connection.







GATEWAY—Check the Gateway address with your network/system administrator if you configure it manually.

DNS—Check the DNS Server IP address with your network/system administrator if you configure it manually.

STORE—Press  to save the changes made in wireless configuration settings.

 **NOTE:**

1. Use  and  buttons to select IP Address, Subnet Mask, Gateway, DNS, and Store.

2. Press the  button to enter IP Address, Subnet Mask, Gateway, or DNS to set the value. (The selected option is highlighted in blue)
 - a Use  and  buttons to select the option.
 - b Use  and  buttons to set the value.
 - c After the setup is complete, press the  button to exit.
3. After the IP Address, Subnet Mask, Gateway, and DNS is set up, select **Store** and press  button to store the settings.
4. If you select **Store** without pressing the **Enter** button, the system will keep the original settings.

RESET—Press  to reset wireless configuration.

MENU SETTINGS—Select and press  to activate the menu settings. The menu settings consists of the following options:

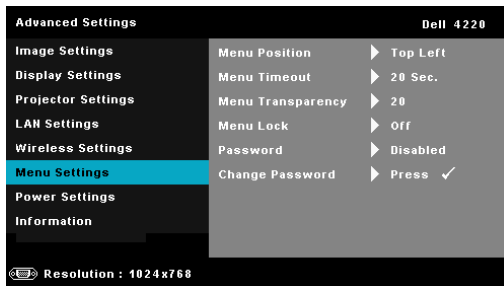

MENU POSITION—Allows you to change the position of the OSD menu on the screen.

MENU TIMEOUT—Allows you to adjust the time for an OSD timeout. By default, the OSD disappears after 20 seconds of non-activity.

MENU TRANSPARENCY—Select to change the transparency level of the OSD background.

MENU LOCK—Select **On** to enable the Menu Lock and hide the OSD menu. Select **Off** to disable the Menu Lock. If you want to disable the Menu Lock function and have the OSD disappear, press the **Menu** button on the control panel or remote control for 15 seconds, and then disable the function.

PASSWORD—When Password Protect is enabled, a Password Protect screen requesting you to enter a password will be displayed when the power plug is inserted into the electrical output and the power for the projector is first turned on. By default, this function is disabled. You can enable this feature by selecting **Enabled**. If the password has been set before, key in the

password first and select the function. This password security feature will be activated the next time you turn on the projector. If you enable this feature, you will be asked to enter the projector's password after you turn on the projector:

1 First time password input request:

- a Go to **Menu Settings**, press  and then select **Password to Enabled** the password settings.

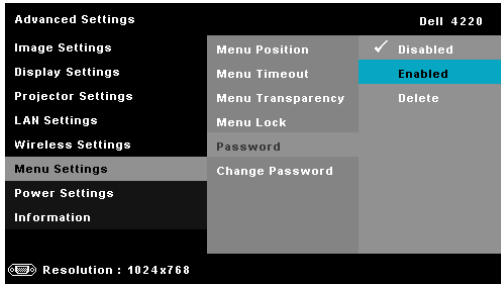

- b Enabling the Password function will pop up a change screen. Key in a 4-digit number from the screen and press .

4220 Password screen

4320 Password screen



- c To confirm, enter the password again.
 - d If the password verification is successful, you may resume with accessing the projector's functions and its utilities.
- 2** If you have entered an incorrect password, you will be given another two chances. After three invalid attempts, the projector will automatically turn off.



NOTE: If you forget your password, contact DELL™ or a qualified service personnel.

- 3** To disable the password function, select the **Disabled** option to close the function.
- 4** To delete the password, select the **Delete** option.

CHANGE PASSWORD—Key in the original password. Then, enter the new password and confirm the new password again.

4220 Change Password screen

4320 Change Password screen

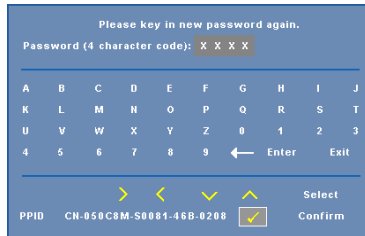
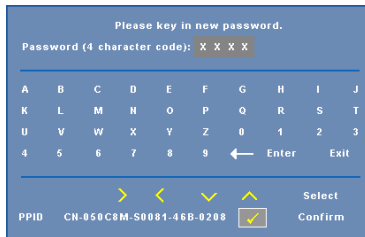
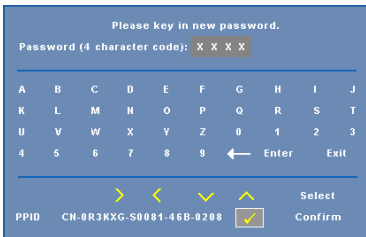
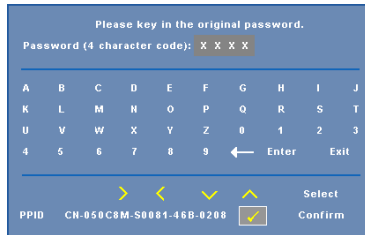
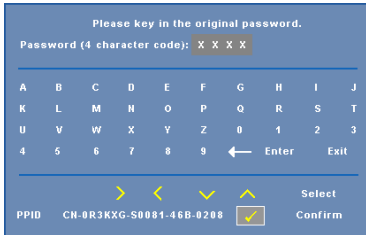

POWER SETTINGS—Select and press to activate power settings. The power settings menu provides the following options:

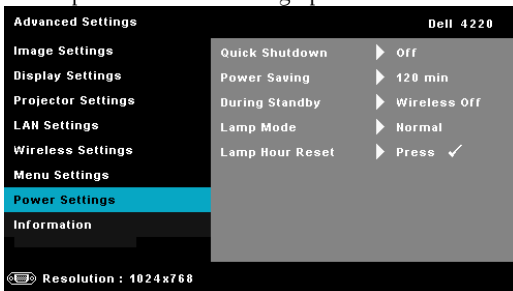

QUICK SHUTDOWN—Select **On** to turn off the projector with a single press of the Power button. This function allows the projector to quickly power off with an accelerated fan speed. Slightly higher acoustic noise is expected during quick power off.



NOTE: Before you turn on the projector again, wait for 60 seconds to allow the internal temperature to stabilize. The projector will take a longer time to turn on if you try to power on immediately. Its cooling fan will run at full speed for about 30 seconds to stabilize the internal temperature.

POWER SAVING—Select **Off** to disable Power Saving mode. By default, the projector is set to enter power saving mode after 120 minutes of no activity. A warning message appears on screen showing a 60 seconds countdown before switching to power saving mode. Press any button during the countdown period to stop the power-saving mode.

You can also set a different delay period to enter power saving mode. The delay period is the time you want the projector to wait without an input signal. Power saving can be set to 30, 60, 90, or 120 minutes.

If an input signal is not detected during the delay period, the projector turns off. To turn on the projector press the Power button.

DURING STANDBY—Select **Wireless On** or **Off** to set the Wireless/LAN module on/off while the projector is standby status (default is Wireless Off).

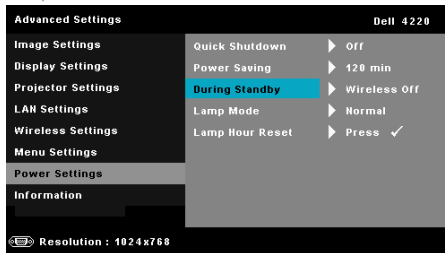

LAMP MODE—Allows you to select between **Normal** or **ECO** mode.

Normal mode operates at full power level. ECO mode operates at a lower power level which may provide longer lamp life, quieter operation, and dimmer luminance output on the screen.

LAMP HOUR RESET—Press and select the **Confirm** option to reset the lamp hour.

INFORMATION—The information menu displays the current 4220 or 4320 projector settings.

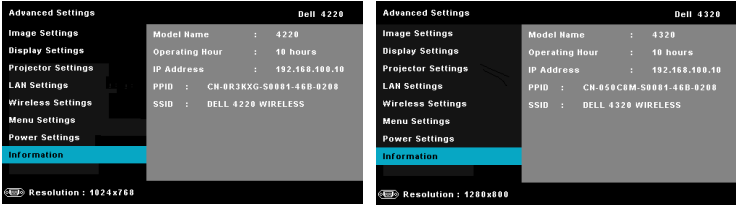

LANGUAGE

Allows you to set the language for the OSD. Press  to activate the Language menu.



HELP

If you encounter problems with your projector, you can access the help menu for troubleshooting.

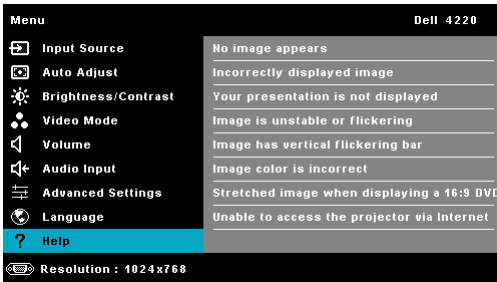

Wireless Networking Installation



NOTE: Your computer must have the following minimum system requirements:

Operating System:

- Windows

Microsoft Windows 2000™ with service pack 4 or later, Windows XP™ Home or Professional Service pack 2 (32-bit recommended), Windows Vista 32-bit, and Windows® 7 Home or Professional 32-bit or 64-bit

- MAC

MacBook and above, MacOS 10.5 and above

Minimum Hardware:

a Intel Dual Core 1.4 MHz or higher

b 256 MB of RAM required, 512 MB or more recommended

c 10 MB of available hard-disk space

d nVidia or ATI graphic card must with 64 MB VRAM or above

e Ethernet adapter (10 / 100 bps) for an Ethernet connection

f A supported WLAN adapter for a WLAN connection (any NDIS-compliant 802.11b or 802.11g or 802.11n WiFi device)

Web browser

Microsoft Internet Explorer 6.0 or 7.0 (recommended) or 8.0, Firefox 1.5 or 2.0, and Safari 3.0 and above



NOTE: Wireless Networking Installation steps are the same for the 4220 and 4320 models.

Enable Wireless on the Projector

In order to use your projector wirelessly, you need to complete the steps below:

- 1 Install the optional wireless dongle. See "Installing the Optional Wireless Dongle" on page 11.
- 2 Connect the power cable to the wall outlet and press the power button.



- 3 Press the Menu button on your projector control panel or remote control.



NOTE: Use , ,  and  buttons to navigate and  to select.

- 4 The wireless connection default is **enable**. See "Wireless Settings" on page 51.
- 5 Access the **INPUT SOURCE** menu, select **Wireless/USB** and then select **Wireless Display** on the sub-menu. See "INPUT SOURCE WIRELESS/USB" on page 39.

The Wireless Guide Screen shown below appears:



NOTE: If wireless connection is disabled, then follow these steps to set up: **ADVANCED SETTINGS** → **Wireless settings** → **Wireless** → **Connected**. The image input source will be automatically switched to wireless screen when wireless option is selected in this step.

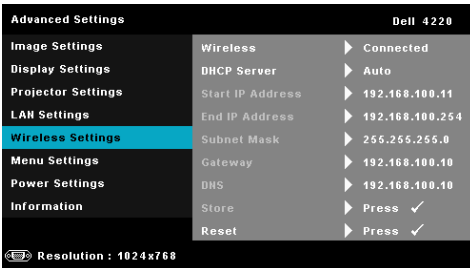

- 6 Take note of the **LOGIN CODE**, **NETWORK NAME (SSID)**, and **IP ADDRESS**. You will need these information to log in later.

Install the Wireless Application software on Your Computer

7 Connect your computer to the 4220 or 4320 wireless network.

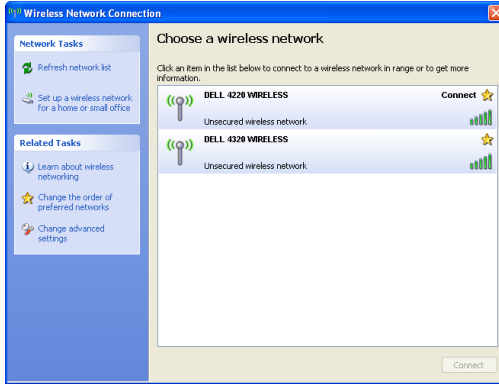

NOTE:

- Your computer must have wireless network function to detect the connection.
- When you connect to the 4220 or 4320 wireless network, you will lose wireless connectivity with other wireless networks.

NOTE: Remember to turn off all proxies. (In Microsoft® Windows Vista: Click Control Panel → Internet Options → Connections → LAN Settings)

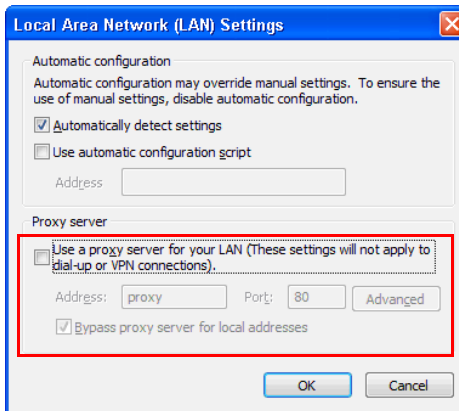

8 Open your Internet browser. You will be automatically directed to the 4220 or 4320 Web Management web page.



NOTE: If the web page does not load automatically, enter the IP address (default IP address is 192.168.100.10) noted from the projector's screen in the browser's address bar.

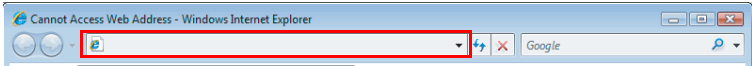

- 9 The 4220 or 4320 Web Management page opens. For first time use, click Download.

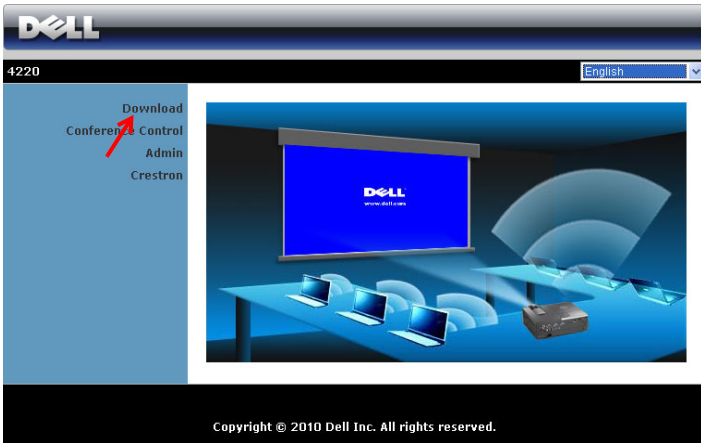

- 10 Select the appropriate operating system, then click Download.

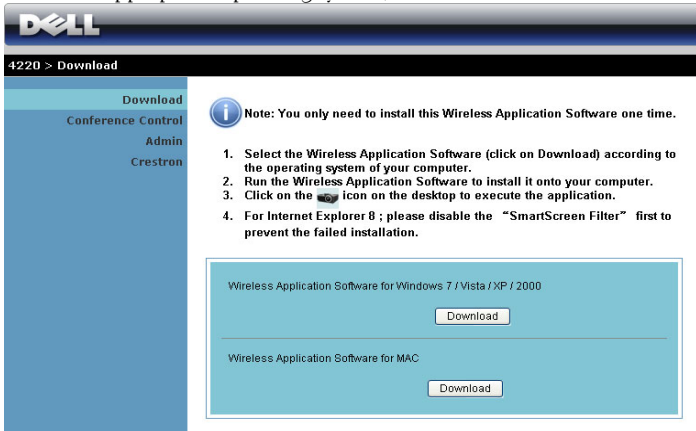

- 11 Click **Run** to proceed with the one-time installation of the software.

 **NOTE:** You may choose to save the file and install it at a latter time. To do this, click **Save**.

 **NOTE:** If you are unable to install the application because of inadequate rights on the computer, please contact your network administrator.

- 12 The installation software will launch. Follow the on-screen instructions to complete setup.

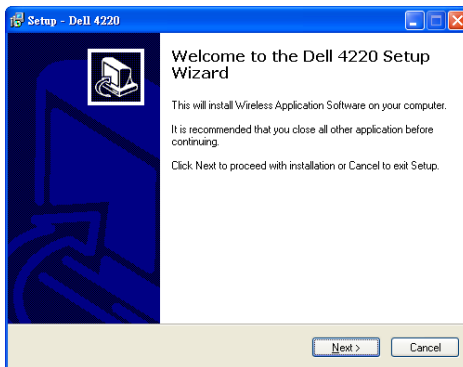
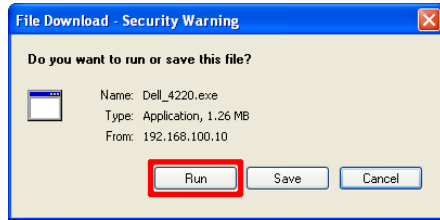

Launch the Wireless Application

Once the installation is complete, the 4220 or 4320 Wireless Application software will launch and will search for the projector automatically. The below screen appears:



Login

To communicate with your projector, enter the Login Code provided in Step 6 of Wireless Networking Installation, then click **OK**.

4220 Log in screen



4320 Log in screen















NOTE: If the **IP Address** is not detected, enter the **IP Address** displayed at the bottom left corner of the screen.

Understanding the Buttons



After a successful log in, the following screen appears:



Projection Mode



Item	Description	
1	Status Bar	Displays IP and LOGIN CODE information.
	 Menu	Click to activate the application menu.
	 Minimize button	Click to minimize the application.
	 Close button	Click to exit the application.
2	Status Mode	
	 Projection Mode	Click to activate the projection mode.
3	Controls Toolbar	
	 Full screen	Click to project the image in full screen.
	 Split 1	Click to project the image in the upper left corner of the screen.
	 Split 2	Click to project the image in the upper right corner of the screen.
	 Split 3	Click to project the image in the lower left corner of the screen.
	 Split 4	Click to project the image in the lower right corner of the screen.
	 Stop	Click to stop projection.
	 Pause	Click to pause projection.
	 Audio Projection	Click to enable audio projection.
	4	Connection Status
 Connection Icon		Blinks when projection is in progress.





Projecting the Presentation

- To project the presentation, click any of the projection buttons .
- To pause the presentation, click . The icon turns green.
- To continue the presentation, click  again.

- To audio projection the presentation, click . See "Audio Projection Installation" on page 73.
- To stop the presentation, click .

Video Mode



Item	Description	
1	Control Toolbar	
	Open	Click to open folder and searching the video or music file.
	Play	Click to starting player.
	Stop	Click to stop player.
	Mute	Click to mute/un-mute.

 **NOTE:** The following information is for wireless data presentation mode only. Image display could be slow or not displayed smoothly if displaying a video clip or animation. Refer to the frame-rate table below for reference:

Frame Rate of Wireless Presentation

Screen Variation % ¹	Estimated frames per second ²
<5 %	30
<10%	28
<20%	26
<40%	25
<75%	22
<= 100%	20

 **NOTE:**

¹ The percentage of screen variation is based on 1024 x 768. Example to display a 320 x 240 video clip on 1024 x 768 desktop, the screen variation is 9.8%.

- 2 Actual frame rate could be different depending on factors such as network environment, image content, signal conditions, locations, and CPU performance.
- 3 Under clean WLAN environment using 802.11g connection, and no screen stretching.
- 4 Compressed to 1024 x 768 and under 802.11g.



NOTE: Your computer will not enter S1 (standby mode) / S3 (sleep mode) / S4 (hibernate mode) when running a wireless, USB Display, or USB Viewer presentation.

Using the Menu

Click  to display the menu.

Web Management	
Search for Projector	
Make Application Token	
<hr/>	
Info	
<hr/>	
About	
Exit	

WEB MANAGEMENT—Click to open the Web Management page. See "Managing the Projector From Web Management" on page 81.

SEARCH FOR PROJECTOR—Click to search and connect to wireless projector.

MAKE APPLICATION TOKEN—Click to make application token. See "Make Application Token" on page 100.

INFO—Click to display system information.

ABOUT—Click to display the application version.

EXIT—Click to close the application.

Presentation to Go (PtG) Installation

Minimum system requirements to install PtG are as follow:

Operating System:

- Windows

Microsoft Windows XP™ Home or Professional Service pack 2/3 (32-bit recommended), Windows Vista 32-bit, or Windows® 7 Home or Professional 32-bit or 64-bit

- Office 2003 or Office 2007



NOTE: Presentation to Go (PtG) installation steps are the same for the 4220 and 4320 models.

In order to use your USB Viewer, you need to complete the steps below:

"Wireless and LAN" option and "Wireless connection" default are enabled.

- 1 Plug the USB Flash to your projector.



NOTE:

- Supports only the JPEG format photo within 10 MB x 40 M pixels.
- The PtG converter can convert your PowerPoint files into PtG files. See "PtG Converter - Lite Application Software" on page 72.
- You can download the "PtG Converter - Lite" from the Dell Support site at: support.dell.com.

- 2 At INPUT SOURCE menu, select Wireless/USB and then select USB Viewer on the sub-menu. See "INPUT SOURCE WIRELESS/USB" on page 39.



NOTE:

- 1 When the Wireless and LAN function is disabled, Go to **LAN Settings** menu, select the "**Enabled**" in the "**Wireless and LAN**" option to activate the Wireless and LAN function.
- 2 When the Wireless connection is disconnected, Go to **Wireless Settings** menu, select the "**Connected**" in the **Wireless** option to enable wireless connection.

PtG Viewer

System will stay in this page when ready.

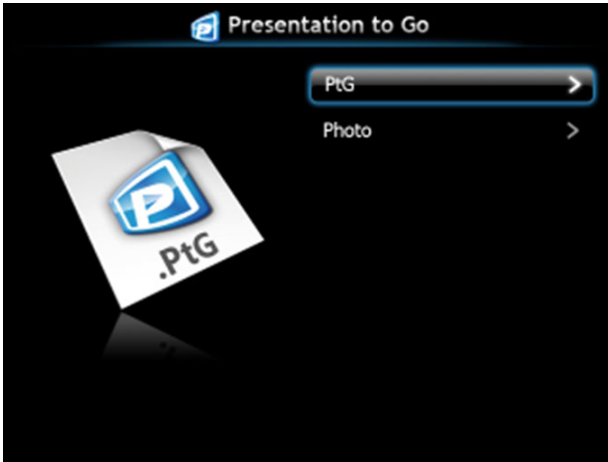
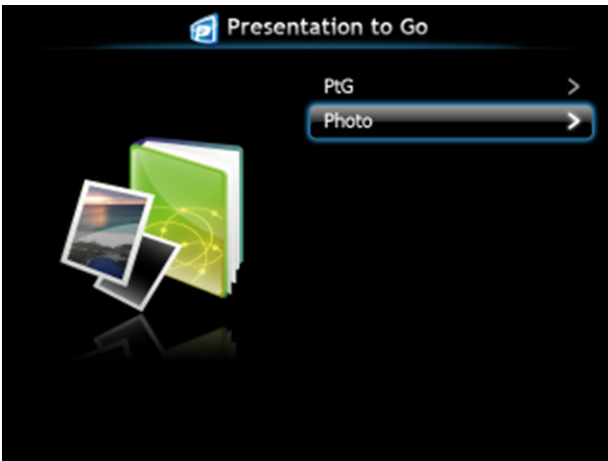



Photo Viewer



PtG/Photo Function Introduction

Show valid PtG and Photo files which are stored in the USB disk.

 **NOTE:** If only one disk is detected, the system will skip this step.

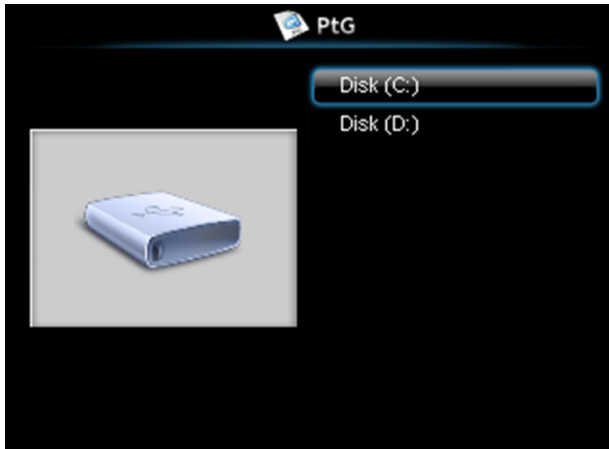

PtG Overview





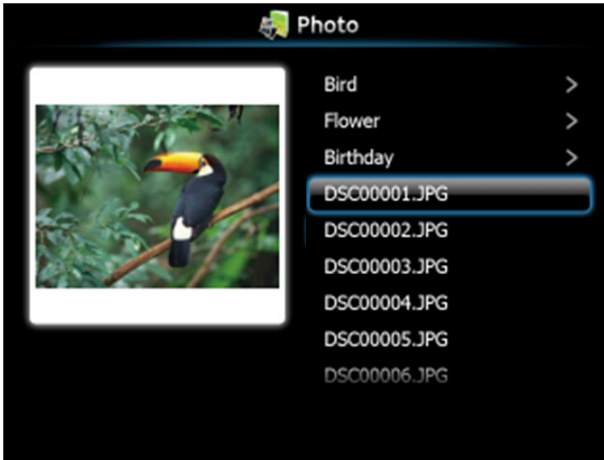



Photo Overview



NOTE: Supports 14 languages of photo files name format (Languages: English, Dutch, French, German, Italian, Japanese, Korean, Polish, Portuguese, Russian, Simplified Chinese, Spanish, Swedish, and Traditional Chinese).

Buttons-Introduction

Use the up, down, and left buttons to navigate and  button on your projector's control panel or remote control to select.

Button	Up 	Down 	Left 	Right 	Enter 
PtG function	Up	Down	Back	No function	Enter
PtG Playback	Pre Page	Next Page	Back	No function	Next Pause
Photo function	Up	Down	Back	No function	Enter
Photo Playback	Pre Page	Next Page	Back	No function	No function

NOTE: If you enter the OSD menu while using PtG, PtG navigation by the up, down, and left buttons will not function.

Set up PtG Converter - Lite

Please follow the on-screen instructions to complete the setup.

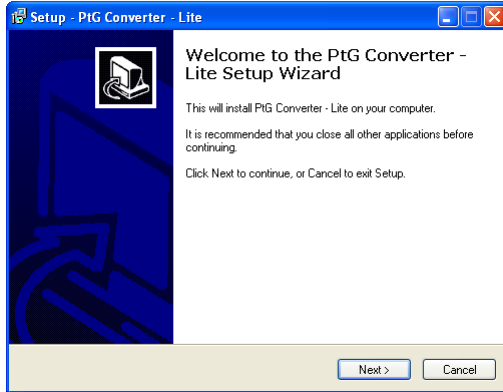

PtG Converter - Lite Application Software

Please launch the "PtG Converter - Lite". The below screen appears:



- 1 Click  to start conversion.
- 2 Select the PowerPoint file you want to convert.

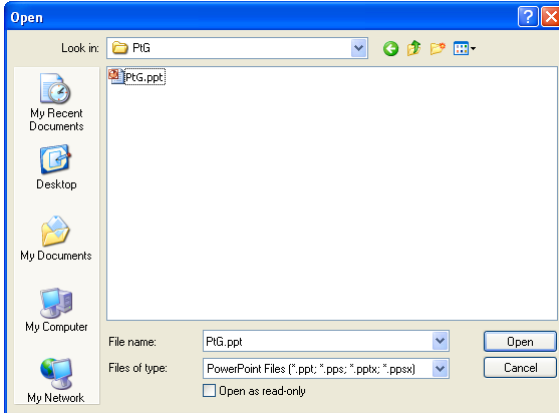

- 3 Click Browse button to select the storage location and then press OK.

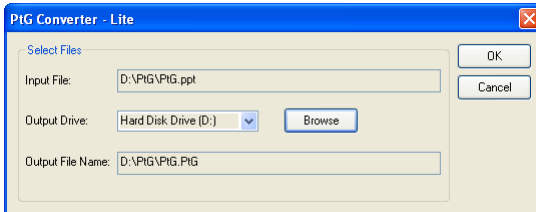

NOTE:

- 1 If your computer does not have MS PowerPoint installed, file convert will fail.
- 2 PtG converter only supports up to 20 pages.
- 3 PtG converter only supports conversion of .ppt files to .PtG files.

Audio Projection Installation

Audio Projection only supports the **Wireless Display** and **LAN Display** source.

Minimum system requirements as follow:

Operation System:

- Windows
Microsoft Windows XP™ Home or Professional Service pack 2/3 (32-bit recommended), Windows Vista 32-bit, or Windows® 7 Home or Professional 32-bit or 64-bit

Minimum Hardware:

- a Intel® Core™ i5-460 MHz (2.53 GHz/Turbo 2.8 GHz) or greater
- b 1 GB DDR3 VRAM independent graphics card or more recommended
- c 2 GB dual channel DDR3 SDRAM memory at 1066 MHz required or more recommended
- d Gigabit Ethernet
- e Integrated 802.11 b/g/n Wi-Fi Device for a WLAN connection



NOTE: Audio Projection function not supports the **MAC** operation system.



NOTE: If your computer does not meet the minimum hardware requirements, audio projection may have lag or noise. Meet the recommended system requirements to have optimized performance of audio projection.



NOTE: Audio Projection Setting steps are the same for the 4220 and 4320 models.

Follow these steps to set up the audio projection function:

Enable Wireless or LAN on the Projector

- 1 Connect the power cable and turn on the projector by pressing the power button.



- 2.1 If you choose the LAN connection mode, follow these steps to enable Wireless and LAN function (default is Enabled): **Advanced Settings** → **LAN Settings** → **Wireless and LAN** → **Enabled**.

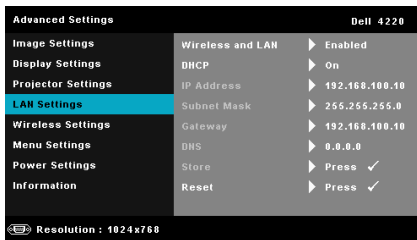

- 2.2 If you choose the wireless connection mode, follow these steps to enable wireless connection (default is Connected): **Advanced Settings** → **Wireless Settings** → **Wireless** → **Connected**.

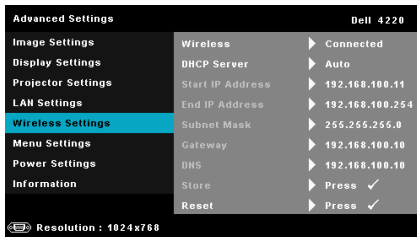

NOTE: If you want to use the wireless connection for 4220 or 4320 projector, need installed the optional wireless dongle. See "Installing the Optional Wireless Dongle" on page 11.

- 3 Access the Input Source menu, select the Wireless/USB and then select the Wireless Display on the sub-menu.

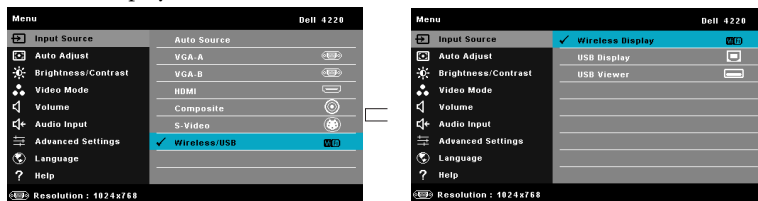

The Wireless Guide Screen shown below appears:





- 4 Take note of the LOGIN CODE, NETWORK NAME (SSID), and IP ADDRESS. You will need these information to log in later.

Install the Dell Wireless Application Software on Your Computer

- 5 Connect the LAN cable to the projector and the computer.



 **NOTE:** If your projector has installed the optional wireless dongle, you can also select the wireless connection. See "Wireless Connection" on page 60.

 **NOTE:** It is recommended that all proxies are *turned off*. (In Microsoft® Windows 7: Click **Control Panel** → **Internet Options** → **Connections** → **LAN Settings**)

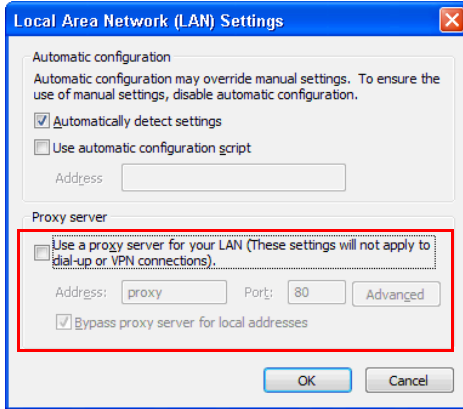



6 "Wireless Application Software" is required if the Wireless or LAN is used for the Audio Projection set-up. Please download and install the software the first time you use Audio Projection. If it is already installed, skip Step 6 - 7.

 **NOTE:** You only need to install the "Wireless Application Software" once.

7 Wireless Application Software download and installation steps refer to "Install the Wireless Application Software" on page 60.

Launch the Wireless Application

- 8 Once the installation is complete, the program will launch automatically. Or you can double-click the icon  or  on the desktop to start the application.



NOTE:

- 1 If you choose LAN connection mode, click "**Skip**".
- 2 If you choose wireless connection mode, select your projector, and then click "**OK**".

Login

- 9 To communicate with your projector, enter the Login Code (see Step 4), and then click OK.

4220 Log in screen



4320 Log in screen



NOTE: If the **IP Address** is not detected, enter the **IP Address** displayed at the bottom left corner of the wireless screen.

- 10 You are now logged into the 4220 or 4320 Wireless Application. Press the "Play" button in the application to starting the LAN or wireless projection.



- NOTE:** You may use the controls to either project in full screen mode or in split screen mode.

- 11 Press the "Audio Projection" button in the application to enable Audio Projection function.



- NOTE:** Audio projector function need install extra driver, if your computer do not install driver, will pop-up need install driver message on screen. You can download the "extra driver" from the Dell Support site at support.dell.com.

- 12 Executing the Windows Media Player or others audio player software (example: Winamp player...) on your computer.



Video Stream Installation

Video Stream only supports the Wireless Display and LAN Display source.

Minimum system requirements as follow:

Operation System:

- Windows
Microsoft Windows XP™ Home or Professional Service pack 2/3 (32-bit recommended), Windows Vista™ 32-bit, or Windows® 7 Home or Professional 32-bit or 64-bit
- MAC
MacBook Pro and above, MacOS 10.5 and above

Minimum Hardware:

- a** Dual® Core™ 1.4 GHz or greater
- b** 64 MB VRAM independent graphics card or more recommended
- c** 2 GB DDR SDRAM memory or more recommended
- d** Gigabit Ethernet
- e** Integrated 802.11 b/g/n Wi-Fi Device for a WLAN connection



NOTE: If your computer does not meet the minimum hardware requirements, video stream may have lag. Meet the recommended system requirements to have optimized performance of the video stream.



NOTE: Video Stream Setting steps are the same for the 4220 and 4320 models.

Video Stream Support Format

File Format	Video Format	Audio Format
MP4	AVC, Mpeg4 visual, H.263	AAC-LC, MP3, AMR NB
MOV	AVC, Mpeg4 visual, H.263	AAC-LC, MP3
ASF	VCI	WMA

Enable Wireless or LAN on the Projector

Please refer to steps 1 to 4 of the Audio Projection Installation to enable wireless or LAN feature.

Install the Dell Wireless Application Software on Your Computer

Please refer to steps 5 to 7 of the Audio Projection Installation to install the Dell Wireless Application Software.

Launch the Wireless Application

Please refer to steps 8 of the Audio Projection Installation to launching the Wireless Application.

Login

Please refer to steps 9 of the Audio Projection Installation to log-in the application.

- 1 You are now logged into the 4220 or 4320 Wireless Application. Click "Video Mode" button switch to Video Mode screen.



- 2 Click  to select the video or music files and starting player.

Managing the Projector From Web Management

Configuring the Network Setting

If the projector is connected to a network, you can access the projector using a web browser. For configuring the network setting, refer to "LAN Settings" on page 50.

Accessing Web Management

Use Internet Explorer 5.0 and above or Firefox 1.5 and above and enter the IP address. You can now access Web Management and manage the projector from a remote location.



NOTE: Web management and set are the same for the 4220 and 4320 models.

Home Page

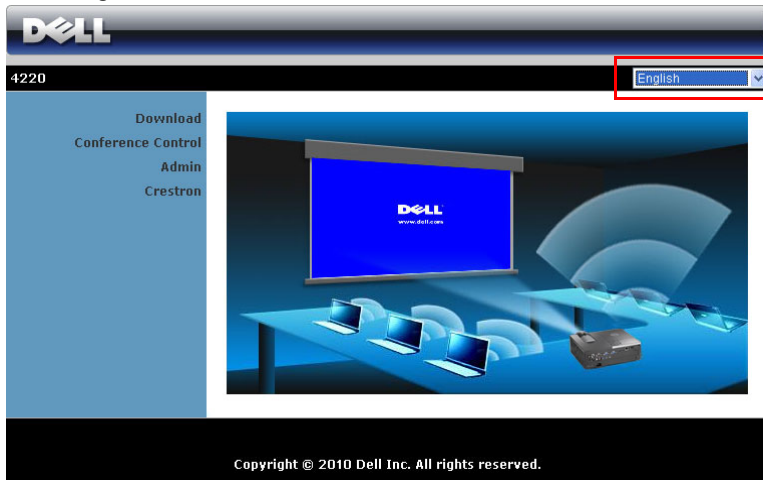

- Access the Web Management Home page by entering the projector's IP address at the web browser. See "LAN Settings" on page 50.
- Select the language for web management from the list.
- Click any menu item on the left tab to access the page.

Download the Wireless Application Software

See also "Wireless Networking Installation" on page 57.

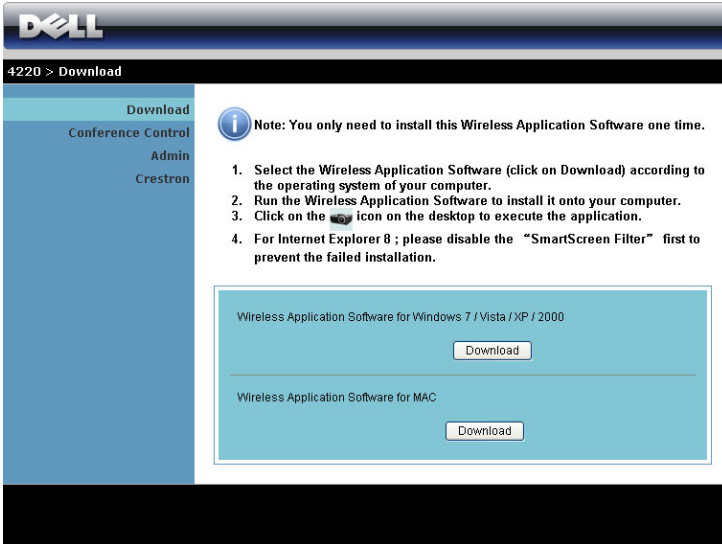

The screenshot shows the Dell website interface. At the top left is the Dell logo. Below it, the breadcrumb path "4220 > Download" is visible. A navigation menu on the left lists "Download", "Conference Control", "Admin", and "Crestron". The main content area features an information icon (i) followed by a note: "Note: You only need to install this Wireless Application Software one time." Below the note is a numbered list of four steps: 1. Select the Wireless Application Software (click on Download) according to the operating system of your computer. 2. Run the Wireless Application Software to install it onto your computer. 3. Click on the [icon] icon on the desktop to execute the application. 4. For Internet Explorer 8 ; please disable the "SmartScreen Filter" first to prevent the failed installation. Below the list is a light blue box containing two download options: "Wireless Application Software for Windows 7 / Vista / XP / 2000" with a "Download" button, and "Wireless Application Software for MAC" with a "Download" button.

Click the **Download** button of the corresponding operating system of your computer.

Conference Control

This allows you to host conference presentations from different sources without using projector cables and lets you control how each presentation will appear on screen.

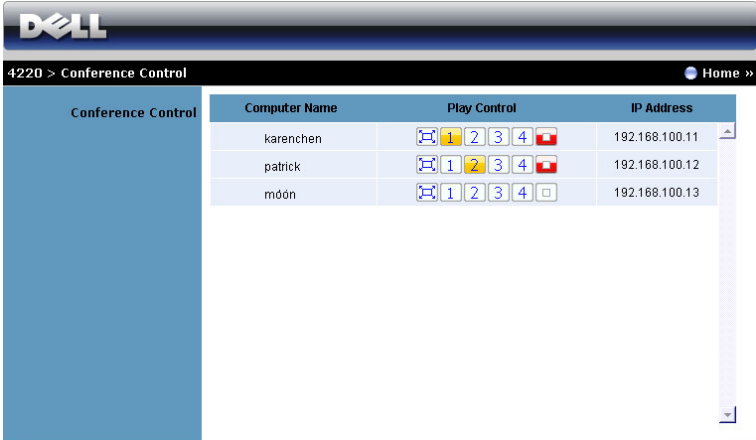

NOTE: Without Conference Play Control, the last user to hit the "Play" button on the application will take control of the full-screen projection.

Computer Name: Lists the computers logged for conference control.

Play Control: Click the buttons to control how each computer's projection will appear on screen.

- Full screen projection — The presentation from the computer occupies the whole screen.
- Split 1 - The presentation from the computer appears on the upper left corner of the screen.
- Split 2- The presentation from the computer appears on the upper right corner of the screen.
- Split 3- The presentation from the computer appears on the lower left corner of the screen.
- Split 4- The presentation from the computer appears on the lower right corner of the screen.
- Stop - Projection from the computer is stopped.

IP Address: Shows each computer's IP Address.

NOTE: To end the conference, click **Home**.

Managing Properties

Admin

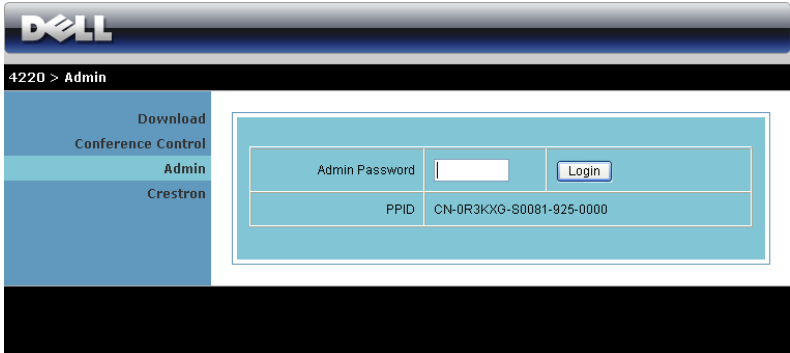

An administrator password is required to access the Admin page.

- **Admin Password:** Enter the administrator password and then click **Login**. The default password is "admin". To change the password, see "Change Passwords" on page 89.

System Status

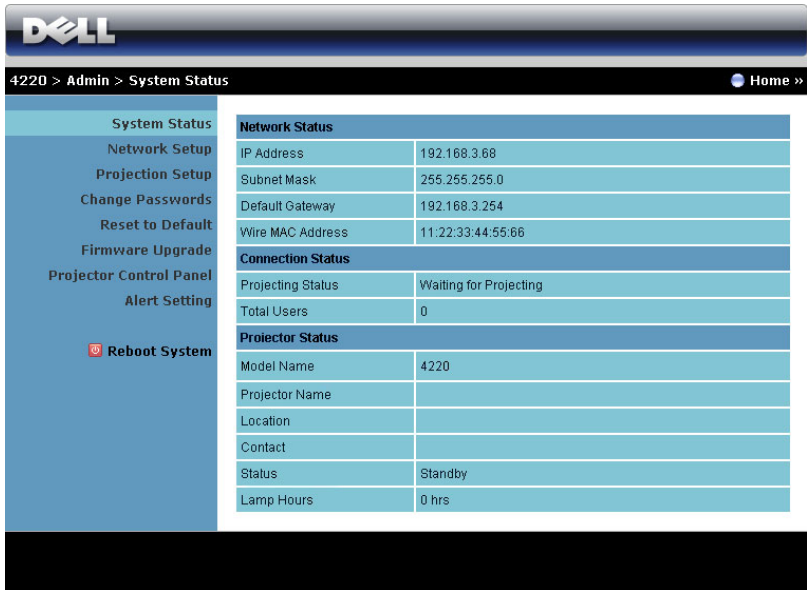

4220 > Admin > System Status Home »

System Status	Network Status	
Network Setup	IP Address	192.168.3.68
Projection Setup	Subnet Mask	255.255.255.0
Change Passwords	Default Gateway	192.168.3.254
Reset to Default	Wire MAC Address	11:22:33:44:55:66
Firmware Upgrade	Connection Status	
Projector Control Panel	Projecting Status	Waiting for Projecting
Alert Setting	Total Users	0
 Reboot System	Projector Status	
	Model Name	4220
	Projector Name	
	Location	
	Contact	
	Status	Standby
	Lamp Hours	0 hrs

Displays the Network Status, Connection Status, and Projector Status information.

Network Status

See OSD section on page 50.

The screenshot shows the Dell 4220 Network Setup OSD menu. The menu is titled "4220 > Admin > Network Setup" and includes options like System Status, Network Setup, Projection Setup, Change Passwords, Reset to Default, Firmware Upgrade, Projector Control Panel, Alert Setting, and Reboot System. The Network Setup section is expanded to show IP Setup, DHCP Server Setup, Wireless Setup, RADIUS Server Setup, GateKeeper, and Set Security For SNMP.

Section	Option	Value
IP Setup	Obtain an IP address automatically	<input checked="" type="radio"/>
	Use the following IP address	<input type="radio"/>
	IP Address	192 168 100 10
	Subnet Mask	255 255 255 0
	Default Gateway	192 168 100 10
DHCP Server Setup	Auto	<input checked="" type="radio"/>
	Disable	<input type="radio"/>
	Start IP	192 168 100 11
	End IP	192 168 100 254
	Subnet Mask	255 255 255 0
Wireless Setup	Wireless LAN	<input checked="" type="radio"/> Enable <input type="radio"/> Disable
	Region	--- WORLDWIDE ---
	SSID	DELL 4220 WIRELESS
	SSID Broadcast	<input checked="" type="radio"/> Enable <input type="radio"/> Disable
	Channel	Auto
	Encryption	Disable
	Key	
RADIUS Server Setup	IP Address	192 168 100 10
	Port	1812
	Key	
GateKeeper	All Pass	<input type="radio"/> All Block <input checked="" type="radio"/> Internet Only <input type="radio"/>
Set Security For SNMP	Write Community	private

IP Setup

- Choose **Obtain an IP address automatically** to assign an IP address to the projector automatically, or **Use the following IP address** to assign an IP address manually.

DHCP Server Setup

- Choose **Auto** to automatically set up the **Start IP**, **End IP**, **Subnet Mask**, **Default Gateway**, and **DNS Server** address from a DHCP server, or **Disable** to disable this function.

Wireless Setup

- Choose **Enable** to set up the **Region**, **SSID**, **SSID Broadcast**, **Channel**, **Encryption**, and **Key**. Choose **Disable** to disable the wireless set up.

SSID: Up to maximum length of 32 characters.

Encryption: You can **Disable** WPA key or select one of 64-bit or 128-bit in ASCII or HEX string.

Key: If Encryption is enabled, you have to set key value according to the encryption mode you selected.

RADIUS Server Setup

- Set up the IP address, Port, and Key information.

GateKeeper

- There are three options:

All Pass: Allow users to access the office network via the wireless projector.

All Block: Block users from accessing the office network via the wireless projector.

Internet Only: Block users from the office network, but still reserve Internet connection capability.

Set Security For SNMP

- Setup Write Community information.

Click the **Apply** button to save and apply changes. The projector must be restarted for the changes to take effect.

Projection Setup

System Status	Resolution	XGA (1024x768) ▾	
Network Setup	Projection Setup	<input type="radio"/> Disable	
Projection Setup		<input checked="" type="radio"/> Random	
Change Passwords		<input type="radio"/> Use the following code <input type="text"/>	
Reset to Default	Projector Setup	Model Name	4220
Firmware Upgrade		Projector Name	D07987
Projector Control Panel		Location	<input type="text"/>
Alert Setting		Contact	<input type="text"/>
Reboot System	<input type="button" value="Apply"/> <input type="button" value="Cancel"/>		

Projection Setup

- **Resolution:** Allows you to select the resolution. Options are: XGA (1024 x 768) and WXGA (1280 x 800).
- **Login Code:** Select how you want the login code to be generated by the projector. There are three options:
 - **Disable:** Login code will not be required when logging in to the system.
 - **Random:** Default is **Random**. Login code will be randomly generated.
 - **Use the following code:** Enter a 4-digit code. This code will be used to log in to the system.

Projector Setup

- Set up the **Model Name**, **Projector Name**, **Location**, and **Contact** information (up to 21 characters for each field).

Click the **Apply** button to save and apply changes. The projector must be restarted for the changes to take effect.

Change Passwords

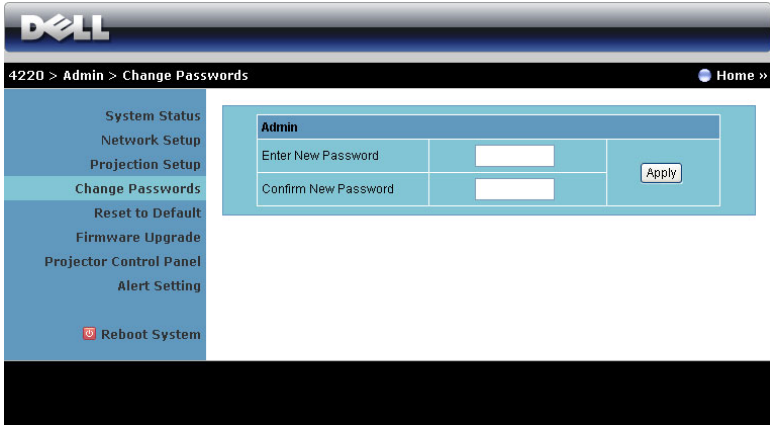

The screenshot shows the Dell Admin interface. At the top left is the Dell logo. Below it is a breadcrumb trail: "4220 > Admin > Change Passwords". On the right side of the breadcrumb trail is a "Home »" link. A vertical navigation menu on the left contains the following items: "System Status", "Network Setup", "Projection Setup", "Change Passwords" (highlighted in light blue), "Reset to Default", "Firmware Upgrade", "Projector Control Panel", "Alert Setting", and "Reboot System" (with a red power icon). The main content area is titled "Admin" and contains a form with two input fields: "Enter New Password" and "Confirm New Password". An "Apply" button is located to the right of the second input field.

This page allows you to change the administrator password.

- **Enter New Password:** Enter the new password.
- **Confirm New Password:** Enter the password again and click **Apply**.



NOTE: Contact Dell if you forget your administrator password.

Reset to Default

The screenshot shows the Dell projector's web interface. At the top, there is a black header with the Dell logo on the left and a navigation bar containing the text "4220 > Admin > Reset to Default" and a "Home" button with a right-pointing arrow. Below the header is a blue sidebar menu with the following items: "System Status", "Network Setup", "Projection Setup", "Change Passwords", "Reset to Default" (highlighted in a lighter blue), "Firmware Upgrade", "Projector Control Panel", "Alert Setting", and "Reboot System" (with a red power icon). The main content area is white and features a light blue box with a yellow warning triangle icon. The text in this box reads "Reset to Default" followed by "This will restore the Wireless/Network to factory default settings." Below this box is a white bar containing an "Apply" button.

Click the **Apply** button to restore the wireless/network setup to its factory default settings.

Firmware Upgrade

Use the Firmware Upgrade page to update your projector's wireless firmware.

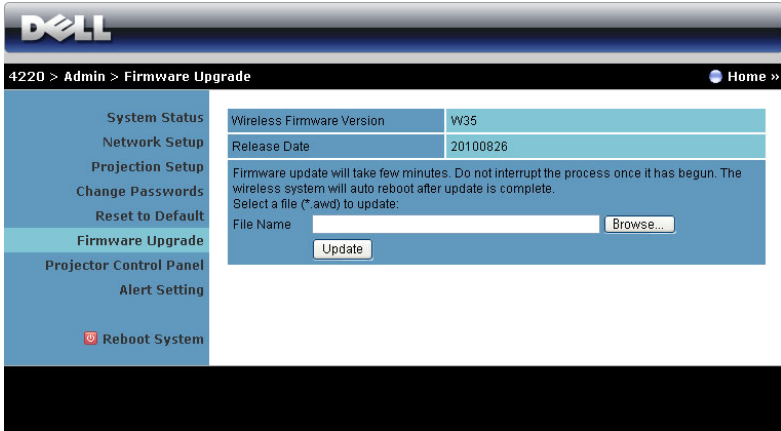

NOTE: Please disable and enable wireless/network using the OSD to restart the network card for the projector after firmware upgrade is successful.

To start the firmware update, follow these steps:

- 1 Press **Browse** to select the file to update.
- 2 Click the **Update** button to start. Wait while the system updates the firmware in your device.

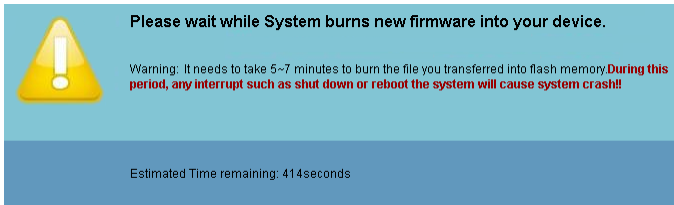

CAUTION: Do not interrupt the update process as this may cause the system to crash!

- 3 Click **OK** when the update is complete.

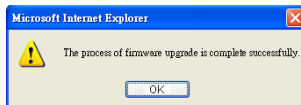

Projector Control Panel

The screenshot shows the Dell Projector Control Panel interface. The top bar features the Dell logo and the breadcrumb "4220 > Admin > Projector Control Panel" with a "Home" link. The left sidebar contains navigation options: System Status, Network Setup, Projection Setup, Change Passwords, Reset to Default, Firmware Upgrade, Projector Control Panel (highlighted), Alert Setting, and Reboot System. The main content area is titled "Projector Information" and includes sections for "Image Control" and "Audio Control".

Projector Information		
Projector Status	On	Refresh
Power Saving	Off	Power ON Power OFF
Alert Status	Good	Clear
Image Control		
Operation Mode	<input checked="" type="radio"/> Normal Mode <input type="radio"/> ECO Mode	
Projector Mode	Front Projection-Desktop	
Source Select	None	
Video Mode	Presentation Mode	
Blank Screen	<input type="radio"/> On <input checked="" type="radio"/> Off	
Aspect Ratio	<input checked="" type="radio"/> Original <input type="radio"/> 4:3 <input type="radio"/> Wide	
Brightness	50 (0~100)	Set
Contrast	50 (0~100)	Set
Auto Adjust		
Audio Control		
Audio Input	Audio-A	
Volume	10 (0~20)	Set
Speaker	<input checked="" type="radio"/> On <input type="radio"/> Off	
Factory Reset		

Projector Information

- **Projector Status:** There are five status: Lamp On, Standby, Power Saving, Cooling, and Warming up. Click **Refresh** to refresh the status and control settings.
- **Power Saving:** Power Saving can be set to Off, 30, 60, 90, or 120 minutes. For more information, see "Power Saving" on page 55.
- **Alert Status:** There are three alert states: Lamp warning, Low lamp life, and Temperature warning. Your projector might lock up in the protection mode if any of the alerts are activated. To exit the protection mode, click **Clear** to clear the Alert Status before you power on your projector.

Image Control

- **Operation Mode:** Allows you to select the operation mode. The two options are: Normal Mode and ECO Mode.
- **Projector Mode:** Allows you to select the projector mode, depending on how the projector is mounted. There are four projection modes: Front Projection-Desktop, Front Projection-Ceiling Mount, Rear Projection-Desktop, and Rear Projection-Ceiling Mount.
- **Source Select:** The Source Select menu allows you to select your projector's input source. You can select VGA-A, VGA-B, S-Video, Composite Video, HDMI, Wireless Display, USB Display, or USB Viewer.
- **Video Mode:** Select a mode to optimize the display image based on how the projector is being used:
 - **Presentation:** Best for presentation slides.
 - **Bright:** Maximum brightness and contrast.
 - **Movie:** For viewing movies and photos
 - **sRGB:** Provides a more accurate color representation.
 - **Custom:** User-preferred settings.
- **Blank Screen:** You can select On or Off.
- **Aspect Ratio:** Allows you to select the aspect ratio to adjust how the image appears.
- **Brightness:** Select value to adjust the brightness of the image.
- **Contrast:** Select value to adjust the display contrast.

Click the **Auto Adjust** button to adjust the settings automatically.

Audio Control

- **Audio Input:** Select the input source. Options are: Audio-A, Audio-B, Audio-C, HDMI, and Wireless/LAN.
- **Volume:** Select the value (0~20) for audio volume.
- **Speaker:** Select **On** to enable the audio function or select **Off** to disable the audio function.

Click the **Factory Reset** button to restore the factory default settings.

Alert Setting

4220 > Admin > Alert Setting Home »

E-Mail Alert

Enable Disable E-Mail Alert Test

To: @

Cc: @

From: @

Subject:

SMTP Setting

Out going SMTP Server:

Username:

Password:

Alert Condition

Lamp warning

Low lamp life

Temperature warning

E-mail Alert

- E-mail Alert: You can set whether to be notified by email (Enable) or not (Disable).
- To/CC/From: You can enter email address of sender (From) and recipients (To/Cc) to receive notification when an abnormality or warning occurs.
- Subject: You can enter the subject line of the email.

Click the **E-mail Alert Test** button to test the e-mail alert settings.

SMTP Setting

- **Out going SMTP server**, **User name**, and **Password** should be provided by your network administrator or MIS.

Alert Condition

- You can select the abnormalities or warnings to be notified by email. When any of the alert conditions occur, an email will be sent to the recipients (To/Cc).

Click the **Save** button to save the settings.



NOTE: E-mail alert is designed to work with a standard SMTP server using the default 25 port. It does not support encryption and authentication (SSL or TLS).

Reboot System

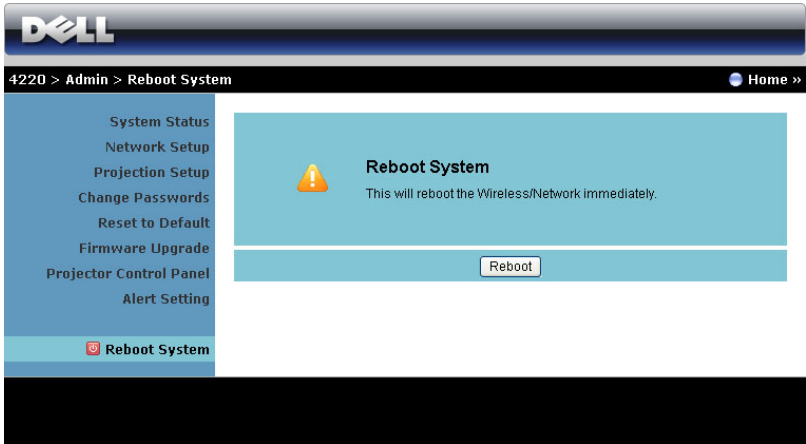

Click Reboot to reboot the system.

Crestron

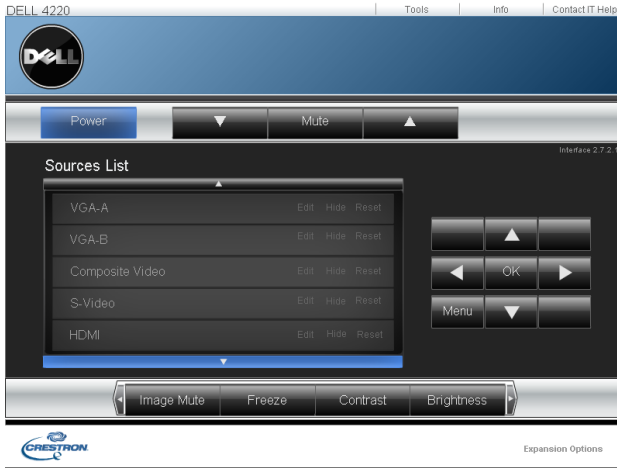

For Crestron function.

FAQS:

I would like to remotely access the projector via the Internet. What is the best setting for the browser?

To have the best setting for the browser, please follow the below steps:

- 1** Open **Control Panel** → **Internet Options** → **General** tab → **Temporary Internet Files** → **Settings** → Select **Every visit to the pages**.
- 2** Some firewall or anti-virus may block the HTTP application. If possible, turn off the firewall or anti-virus.

I would like to remotely access the projector via Internet. What socket port number should I open for it in the firewall?

The following are the TCP/IP socket ports which the projector uses.

UDP/TCP	Port Number	Description
TCP	80	Web configuration (HTTP)
UDP/TCP	25	SMTP: used for email routing between mail servers
UDP/TCP	161	SNMP: Simple Network Management Protocol
UDP	9131	AMX: used for AMX discovery

Why am I unable to access the projector via the Internet?

- 1** Check whether your computer/laptop is connected to the Internet.
 - 2** Check with your MIS or network administrator whether your computer/laptop is in the same subnet.
-

Why am I unable to access the SMTP server?

- 1** Check with your MIS or network administrator whether the SMTP server function is open for the projector and the IP assigned to the projector is allowed to access the SMTP server. The projector's SMTP socket port number is 25, this cannot be changed.
- 2** Check if the outgoing SMTP server, user name, and password are set correctly.
- 3** Some SMTP servers will check whether the mail address of "From" correlates with the "User name" and "Password". For example, you use test@dell.com as the mail address in "From". You should also use test@dell.com account information for the User name and the password to log in the SMTP server.

Why am I unable to receive the test alert email even though the projector already indicates the test mail is already sent?

It could be because the SMTP server recognized the alert mail as a spam mail or because of the SMTP server restriction. Check with your MIS or network administrator for the SMTP server's setting.

Firewall Configuration and FAQ

Q: Why can't I access the Web Management Page?

A: Your computer's firewall configuration may prevent you from accessing the Web Management Web Page. Please refer to the following configuration settings:

Firewall Protection	Configuration
McAfee Security Center	<ol style="list-style-type: none">1 Launch McAfee Security Center (Start > All Programs > McAfee > McAfee Security Center).2 On the personal firewall plus tab, click View the Internet Applications List.3 Find and select Dell 4220 or 4320 Projector from the list.4 Right-click on its Permissions column.5 Select Allow Full Access from the pop-up menu.
Norton AntiVirus	<ol style="list-style-type: none">1 Open Norton AntiVirus (Start > All Programs > Norton AntiVirus > Norton AntiVirus).2 Click Options menu, then select Norton AntiVirus.3 On the Status page, select Internet Worm Protection.4 Find and select Dell 4220 or 4320 Projector from the list of programs.5 Right-click on its Internet Access column.6 Select Permit All from the pop-up menu.7 Click OK.
Sygate Personal Firewall	<ol style="list-style-type: none">1 Open Sygate Personal Firewall (Start > All Programs > Sygate > Sygate Personal Firewall).2 From the Running Applications list, find and right-click on Dell 4220 or 4320 Projector.3 Select Allow from the pop-up menu.

Firewall Protection	Configuration
Windows Firewall	<ol style="list-style-type: none"> 1 Open Windows Firewall (Start > All Programs > Control Panel). Double-click on Windows Firewall. 2 On the General tab, uncheck Don't allow exceptions. 3 On the Exceptions tab, click the Add Program... button. 4 Find and select Dell 4220 or 4320 Projector from the list of programs, then click OK. 5 Click OK to confirm exceptions settings.
Zone Alarm	<ol style="list-style-type: none"> 1 Open Zone Alarm Firewall (Start > All Programs > Zone Labs > Zone Labs Center). 2 On the Program Control page, find and select Dell 4220 or 4320 Projector from the list. 3 Right-click on its Access-Trusted column. 4 Select Allow from the pop-up menu. 5 Right-click and select Allow for the Access-Internet, Server-Trusted, and Server-Internet columns.

Make Application Token

The Application Token lets you perform Plug and Show using a USB token.

- 1 From the application software, click  > **Make Application Token**.
- 2 The following screen appears. Click **Next**.



- 3 Plug a flash drive into any of the USB ports on your computer. Select the drive from the list, then click **Next**.

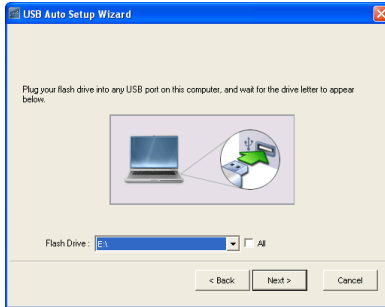

- 4 Click **Finish** to close the wizard.



Troubleshooting Your Projector

If you experience problems with your projector, see the following troubleshooting tips. If the problem persists, contact Dell™ (see *Contacting Dell™* on page 115).



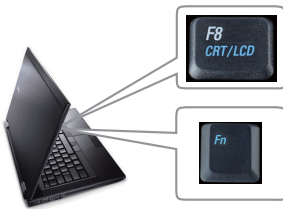

Problem

No image appears on the screen



Possible Solution

- Ensure that the lens cap is removed and the projector is turned on.
 - Ensure that you have chosen the correct input source on the INPUT SOURCE menu.
 - Ensure the external graphics port is enabled. If you are using a Dell™ laptop computer, press **Fn** **F8** (Fn+F8). For other computers, see your respective documentation. If images are not displayed properly, please upgrade the video driver of your computer. For Dell computers, see support.dell.com.
 - Ensure that all the cables are securely connected. See "Connecting Your Projector" on page 10.
 - Ensure that the pins of the connectors are not bent or broken.
 - Ensure that the lamp is securely installed (see "Changing the Lamp" on page 106).
 - Use **Test Pattern** in the **Projector Settings of the Advanced Settings** menu. Ensure that the colors of the test pattern are correct.
-

Problem (continued)	Possible Solution (continued)
Partial, scrolling, or incorrectly displayed image	<ol style="list-style-type: none"> 1 Press the Auto Adjust button on the remote control or the control panel. 2 If you are using a Dell™ portable computer, set the resolution of the computer to WXGA (1280 x 800) or XGA (1024 x 768): <ol style="list-style-type: none"> a Right-click the unused portion of your Microsoft® Windows® desktop, click Properties, and then select Settings tab. b Verify that the setting is 1280 x 800 or 1024 x 768 pixels for the external monitor port. c Press   (Fn+F8). <p>If you experience difficulty in changing resolutions, or if your monitor freezes, restart all the equipment and the projector.</p> <p>If you are not using a Dell™ portable computer, see your documentation. If images are not displayed properly, please upgrade the video driver of your computer. For a Dell computer, see support.dell.com.</p>
The screen does not display your presentation	If you are using a portable computer, press   (Fn+F8).
Image is unstable or flickering	Adjust the tracking in the OSD Display Settings of the Advanced Settings menu (in PC Mode only).
Image has vertical flickering bar	Adjust the frequency in the OSD Display Settings of the Advanced Settings menu (in PC Mode only).
Image color is incorrect	<ul style="list-style-type: none"> • If the display receives the wrong signal output from the graphics card, please set the signal type to RGB in the OSD Image Settings of the Advanced Settings tab. • Use Test Pattern in the Projector Settings of the Advanced Settings menu. Ensure that the colors of the test pattern are correct.

Problem (continued)	Possible Solution (continued)
Image is out of focus	<ol style="list-style-type: none"> 1 Adjust the focus ring on the projector lens. 2 Ensure that the projection screen is within the required distance from the projector (3.94 ft [1.2 m] to 32.81 ft [10 m]).
The image is stretched when displaying a 16:9 DVD	<p>The projector automatically detects the input signal format. It will maintain the aspect ratio of the projected image according to input signal format with an Original setting.</p> <p>If the image is still stretched, adjust the aspect ratio in the Display Settings of the Advanced Settings menu in the OSD.</p>
Image is reversed	Select Projector Settings of the Advanced Settings from the OSD and adjust the projector mode.
Lamp is burned out or makes a popping sound	When the lamp reaches its end of life, it may burn out and may make a loud popping sound. If this occurs, the projector does not turn back on. To replace the lamp, see "Changing the Lamp" on page 106.
LAMP light is solid amber	If the LAMP light is solid amber, replace the lamp.
LAMP light is blinking amber	<p>If the LAMP light is blinking amber, the lamp module connection may be disrupted. Please check the lamp module and ensure that it is properly installed.</p> <p>If the LAMP light and the Power light are blinking amber, the lamp driver has failed and the projector will automatically shut down.</p> <p>If the LAMP and TEMP lights are blinking amber and the Power light is solid blue, the color wheel has failed and the projector will automatically shut down.</p> <p>To clear the protection mode, press and hold the POWER button for 10 seconds.</p>

Problem (continued)	Possible Solution (continued)
TEMP light is solid amber	The projector has overheated. The display automatically shuts down. Turn the display on again after the projector cools down. If the problem persists, contact Dell™.
TEMP light is blinking amber	If the projector fan fails, the projector will automatically shut down. Try to clear the projector mode by pressing and holding the Power button for 10 seconds. Please wait for about 5 minutes and try to power up again. If the problem persists, contact Dell™.
The OSD does not appear on the screen	Try to press the Menu button on the panel for 15 seconds to unlock the OSD. Check the Menu Lock on page 52.
The remote control is not operating smoothly or works only within a limited range	The battery may be low. Check if the laser beam transmitted from the remote is too dim. If so, replace with two new AAA batteries.

Guiding Signals

Projector Status	Description	Control Buttons	Indicator	
		Power	TEMP (Amber)	LAMP (Amber)
Standby mode	Projector in Standby mode. Ready to power on.	BLUE Flashing	OFF	OFF
Warming up mode	Projector takes some time to warm up and power on.	BLUE	OFF	OFF
Lamp on	Projector in Normal mode, ready to display an image.  Note: The OSD menu is not accessed.	BLUE	OFF	OFF
Cooling mode	Projector is cooling to shutdown.	BLUE	OFF	OFF
Cooling before Power Saving mode	The projector takes 60 seconds to cool down before entering Power Saving mode.	AMBER	OFF	OFF
Projector overheated	Air vents might be blocked or ambient temperature may be above 35 °C. The projector automatically shuts down. Ensure that the air vents are not blocked and that the ambient temperature is within operational range. If the problem persists, contact Dell.	OFF	AMBER	OFF
Lamp driver overheated	The lamp driver is overheated. The air vents may be blocked. The projector automatically shuts down. Turn the display on again after the projector cools down. If the problem persists, contact Dell.	AMBER	AMBER	OFF
Fan breakdown	One of the fans has failed. The projector automatically shuts down. If the problem persists, contact Dell.	OFF	AMBER Flashing	OFF
Lamp driver breakdown	The lamp driver has failed. The projector automatically shuts down. Unplug the power cord after three minutes and then turn the display on again. If this problem persists, contact Dell.	AMBER Flashing	OFF	AMBER Flashing
Color Wheel breakdown	Color wheel cannot start. The projector has failed and the projector automatically shuts down. Unplug the power cord after three minutes and then turn on the projector. If this problem persists, contact Dell.	BLUE	AMBER Flashing	AMBER Flashing
Lamp failure	Lamp is defective. Replace the lamp.	OFF	OFF	AMBER
Fault - DC supply (+12V)	Power supply has been interrupted. The projector automatically shuts down. Unplug the power cord after three minutes and then turn on the projector. If this problem persists, contact Dell.	AMBER Flashing	AMBER	AMBER
Lamp module connection failed	Lamp module connection may be disrupted. Check the lamp module and ensure that it is properly installed. If the problem persists, contact Dell.	OFF	OFF	AMBER Flashing

Changing the Lamp

CAUTION: Before you begin any of the procedures in this section, follow the Safety Instructions as described on page 8.

Replace the lamp when the message "**Lamp is approaching the end of its useful life in the operation. Replacement suggested! www.dell.com/lamps**" appears on the screen. If this problem persists after replacing the lamp, contact Dell™. For more information, see *Contacting Dell™* on page 115.

CAUTION: Use an original lamp to ensure safe and optimal working condition of your projector.

CAUTION: The lamp becomes very hot when in use. Do not attempt to replace the lamp until the projector has been allowed to cool down for at least 30 minutes.

CAUTION: Do not touch the bulb or the lamp glass at any time. Projector lamps are very fragile and may shatter if touched. The shattered glass pieces are sharp and can cause injury.

CAUTION: If the lamp shatters, remove all broken pieces from the projector and dispose or recycle according to state, local, or federal law. For more information see www.dell.com/hg.

- 1 Turn off the projector and disconnect the power cord.
- 2 Let the projector cool for at least 30 minutes.
- 3 Loosen the two screws that secure the lamp cover, and remove the cover.
- 4 Loosen the two screws that secure the lamp.
- 5 Pull the lamp up by its metal handle.

NOTE: Dell™ may require lamps replaced under warranty to be returned to Dell™. Otherwise, contact your local waste disposal agency for the address of the nearest deposit site.

- 6 Replace with the new lamp.
- 7 Tighten the two screws that secure the lamp.
- 8 Replace the lamp cover and tighten the two screws.
- 9 Reset the lamp usage time by selecting "Yes" for **Lamp Reset** in the **OSD Power Settings** of the **Advanced Setting** menu (see *Power Settings of the Advanced*



Setting menu on page 54). When a new lamp module has been changed, the projector will automatically detect and reset the lamp hours.



CAUTION: Lamp Disposal (for the US only)

 LAMP(S) INSIDE THIS PRODUCT CONTAIN MERCURY AND MUST BE RECYCLED OR DISPOSED OF ACCORDING TO LOCAL, STATE, OR FEDERAL LAWS. FOR MORE INFORMATION, GO TO WWW.DELL.COM/HG OR CONTACT THE ELECTRONIC INDUSTRIES ALLIANCE AT WWW.EIAE.ORG. FOR LAMP-SPECIFIC DISPOSAL INFORMATION, CHECK WWW.LAMPRECYCLE.ORG.

Specifications

Light Valve	4220: 0.55" XGA S450 DMD, DarkChip3™ 4320: 0.65" WXGA S450 DMD, DarkChip3™
Brightness	4220: 4100 ANSI Lumens (Max.) 4320: 4300 ANSI Lumens (Max.)
Contrast Ratio	2000:1 Typical (Full On/Full Off)
Uniformity	80% Typical (Japan Standard - JBMA)
Number of Pixels	4220: 1024 x 768 (XGA) 4320: 1280 x 800 (WXGA)
Displayable Color	1.07 billion colors
Color Wheel Speed	2X 1X for 3D Display
Projection Lens	F-Stop: F/2.4~2.66 Focal length, f=18.2~21.8 mm 1.2X manual Zoom Lens, Fix 4220: Throw ratio = 1.6~1.92 wide and tele 4320: Throw ratio = 1.28~1.536 wide and tele
Projection Screen Size	4220: 30.8~307 inches (diagonal) 4320: 36.3~362 inches (diagonal)
Projection Distance	3.94~32.81 ft (1.2 m~10 m)
Video Compatibility	Composite Video / S-Video: NTSC (J, M, 4.43), PAL (B, D, G, H, I, M, N, Nc, 60), SECAM (B, D, G, K, K1, L) Component Video input via VGA: 1080i, 720p, 576i/p, 480i/p Component Video input via HDMI: 1080p, 720p, 576i/p, 480i/p
Power Supply	Universal AC 100-240 50-60 Hz with PFC input

Power Consumption

Normal mode: 375 W \pm 10% @ 110 Vac
(Network On)
Eco mode: 320 W \pm 10% @ 110 Vac (Network On)
Power saving mode: <10 W (Wireless and
Network On)
Standby mode: < 0.5 W (Network, VGA_Out, and
Wireless Off)

Audio

2 speakers x 5 watt RMS

Noise Level

35 dB(A) Normal mode, 32 dB(A) Eco mode

Weight

6.4 lb (2.9 kg) \pm 0.05 lb

Dimensions (W x H x D)

11.26 x 4.33 x 9.76 inches (286 x 110 x 247.8 mm)



Environmental

Operating temperature: 5 °C - 35 °C (41 °F- 95 °F)
Humidity: 80 % maximum
Storage temperature: 0 °C to 60 °C (32 °F to 140 °F)
Humidity: 90 % maximum
Shipping temperature: -20 °C to 60 °C
(-4 °F to 140 °F)
Humidity: 90 % maximum

I/O Connectors

Power: One AC power socket (3-pin - C14 inlet)
VGA input: Two 15-pin D-sub connectors (Blue),
VGA-A and VGA-B, for analog RGB/Component
input signals.
VGA output: One 15-pin D-sub connector (Black)
for VGA-A loop through.
S-Video input: One standard 4-pin min-DIN
S-Video connector for Y/C signal.

Composite Video input: One Yellow RCA jack for CVBS signal.

HDMI input: One HDMI connector for supporting HDMI 1.3. HDCP compliant.

Analog Audio input: Two 3.5 mm stereo mini phone jack (Blue) and one pair of RCA connector (Red/White).

Variable audio output: One 3.5 mm stereo mini phone jack (Green).

USB (type A) port: One USB connector for Photo/PtG viewer (JPG/PPT format).

USB (type B) port: One mini USB slave for remote support and One USB connector for supporting USB Display.

RS232 port: One mini-DIN 6-pin for RS232 communication.

RJ45 port: One RJ45 connector for control of projector through network and LAN Display.

12 V output: One 12 V DC / 200 mA max. relay output for driving automatic screen.

Wireless Dongle

Wireless Standard: IEEE802.11b/g/n

Wireless: One WiFi USB (type A) connector for supporting wireless dongle (USB interface, Optional).

OS environment: Windows 7/Vista/XP/2000, MAC OS X

Support: Presentation slides and projector control.

Allow connection up to 30 users at the same time.

4-to-1 split screen. Allow four presentation slides to be projected on screen.

Conference Control mode.

Supports Audio Projection (need to install extra driver)

Lamp

Philips 300 W user-replaceable lamp (up to 2500 hours in eco mode)



NOTE: The lamp life rating for any projector is a measure of brightness degradation only, and is not a specification for the time it takes a lamp to fail and cease light output. Lamp life is defined as the time it takes for more than 50 percent of a lamp sample population to have brightness decrease by approximately 50 percent of the rated lumens for the specified lamp. The lamp life rating is not guaranteed in any way. The actual operating life span of a projector lamp will vary according to operating conditions and usage patterns. Usage of a projector in stressful conditions which may include dusty environments, under high temperatures, many hours per day, and abrupt powering-off will most likely result in a lamp's shortened operating life span or possible lamp failure.

RS232 Pin Assignment

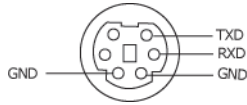

RS232 Protocol

- Communication Settings

Connection settings	Value
Baud Rate	19,200
Data Bits	8
Parity	None
Stop Bits	1

- Command types

To pop up the OSD menu and adjust the settings.

- Control command Syntax (From PC to Projector)

[H][AC][SoP][CRC][ID][SoM][COMMAND]

- Example: Power ON Command (Send low byte firstly)

--> 0xBE, 0xEF, 0x10, 0x05, 0x00, 0xC6, 0xFF, 0x11, 0x11, 0x01, 0x00, 0x01

- Control Commands List

To view the latest RS232 code, go to the Dell Support site at: support.dell.com.

Compatibility Modes (Analog/Digital)

Resolution	Refresh Rate (Hz)	Hsync Frequency (KHz)	Pixel Clock (MHz)
640 x 350	70.087	31.469	25.175
640 x 480	59.940	31.469	25.175
640 x 480 p60	59.940	31.469	25.175
720 x 480 p60	59.940	31.469	27.000
720 x 576 p50	50.000	31.250	27.000
720 x 400	70.087	31.469	28.322
640 x 480	75.000	37.500	31.500
848 x 480	60.000	31.020	33.750
640 x 480	85.008	43.269	36.000
800 x 600	60.317	37.879	40.000
800 x 600	75.000	46.875	49.500
800 x 600	85.061	53.674	56.250
1024 x 768	60.004	48.363	65.000
1280 x 720 p50	50.000	37.500	74.250
1280 x 720 p60	60.000	45.000	74.250
1920 x 1080 i50	50.000	28.125	74.250
1920 x 1080 i60	60.000	33.750	74.250
1280 x 720	59.855	44.772	74.500
1024 x 768	75.029	60.023	78.750
1280 x 800	59.810	49.702	83.500
1366 x 768	59.790	47.712	85.500
1360 x 768	60.015	47.712	85.500
1024 x 768	84.997	68.677	94.500
1440 x 900	59.887	55.935	106.500
1152 x 864	75.000	67.500	108.000
1280 x 960	60.000	60.000	108.000
1280 x 1024	60.020	63.981	108.000
1152 x 864	85.000	77.095	119.651
1400 x 1050	59.978	65.317	121.750
1280 X 800	84.880	71.554	122.500
1280 x 1024	75.025	79.976	135.000
1440 X 900	74.984	70.635	136.750
1680 x 1050	59.954	65.290	146.250
1280 x 960	85.002	85.938	148.500
1920 x 1080	60.000	67.500	148.500
1400 X 1050	74.867	82.278	156.000
1280 x 1024	85.024	91.146	157.000
1440 X 900	84.842	80.430	157.000
1600 x 1200	60.000	75.000	162.000

800 x 600	119.972	76.302	73.250
1024 x 768	119.989	97.551	115.500
1280 x 720	120.000	101.563	146.250

Contacting Dell

For customers in the United States, call 800-WWW-DELL (800-999-3355).



NOTE: If you do not have an active Internet connection, you can find contact information on your purchase invoice, packing slip, bill, or Dell product catalog.

Dell™ provides several online and telephone-based support and service options. Availability varies by country and product, and some services may not be available in your area. To contact Dell for sales, technical support, or customer service issues:

- 1 Visit support.dell.com.
- 2 Verify your country or region in the **Choose A Country/Region** drop-down menu at the bottom of the page.
- 3 Click **Contact Us** on the left side of the page.
- 4 Select the appropriate service or support link based on your need.
- 5 Choose the method of contacting Dell that is convenient for you.

Appendix: Glossary

ANSI LUMENS — A standard for measuring the brightness. It is calculated by dividing a square meter image into nine equal rectangles, measuring the lux (or brightness) reading at the center of each rectangle, and averaging these nine points.

ASPECT RATIO — The most popular aspect ratio is 4:3 (4 by 3). Early television and computer video formats are in a 4:3 aspect ratio, which means that the width of the image is $\frac{4}{3}$ times the height.

Brightness — The amount of light emitted from a display or projection display or projection device. The brightness of projector is measured by ANSI lumens.

Color Temperature — The color appearance of white light. Low color temperature implies warmer (more yellow/red) light while high color temperature implies a colder (more blue) light. The standard unit for color temperature is Kelvin (K).

Component Video — A method of delivering quality video in a format that consists of the luminance signal and two separate chrominance signals and are defined as Y'Pb'Pr' for analog component and Y'Cb'Cr' for digital component. Component video is available on DVD players.

Composite Video — A video signal that combines the luma (brightness), chroma (color), burst (color reference), and sync (horizontal and vertical synchronizing signals) into a signal waveform carried on a single wire pair. There are three kinds of formats, namely, NTSC, PAL, and SECAM.

Compressed Resolution — If the input images are of higher resolution than the native resolution of the projector, the resulting image will be scaled to fit the native resolution of the projector. The nature of compression in a digital device means that some image content is lost.

Contrast Ratio — Range of light and dark values in a picture, or the ratio between their maximum and minimum values. There are two methods used by the projection industry to measure the ratio:

- 1 *Full On/Off* — measures the ratio of the light output of an all white image (full on) and the light output of an all black (full off) image.
- 2 *ANSI* — measures a pattern of 16 alternating black and white rectangles. The average light output from the white rectangles is divided by the average light output of the black rectangles to determine the ANSI contrast ratio.

Full On/Off contrast is always a larger number than ANSI contrast for the same projector.

dB — decibel — A unit used to express relative difference in power or intensity, usually between two acoustic or electric signals, equal to ten times the common logarithm of the ratio of the two levels.

Diagonal Screen — A method of measuring the size of a screen or a projected image. It measures from one corner to the opposite corner. A 9 ft high and 12 ft wide, screen has a diagonal of 15 ft. This document assumes that the diagonal dimensions are for the traditional 4:3 ratio of a computer image as per the example above.

DHCP — Dynamic Host Configuration Protocol — A network protocol that enables a server to automatically assign a TCP/IP address to a device.

DLP® — Digital Light Processing™ — Reflective display technology developed by Texas Instruments, using small manipulated mirrors. Light passing through a color filter is sent to the DLP mirrors which arrange the RGB colors into a picture projected onto screen, also known as DMD.

DMD — Digital Micro-Mirror Device — Each DMD consists of thousands of tilting, microscopic aluminum alloy mirrors mounted on a hidden yoke.

DNS — Domain Name System — An Internet service that translates domain names into IP addresses.

Focal Length — The distance from the surface of a lens to its focal point.

Frequency — It is the rate of repetition in cycles per seconds of electrical signals. Measured in Hz (Hertz).

HDCP — High-Bandwidth Digital-Content Protection — A specification developed by Intel™ Corporation to protect digital entertainment across digital interface, such as DVI, HDMI.

HDMI — High-Definition Multimedia Interface — HDMI carries both uncompressed high definition video along with digital audio and device control data in a single connector.

Hz (Hertz) — Unit of frequency.

IEEE802.11 — A set of standards for wireless local area network (WLAN) communication. 802.11b/g/n uses the 2.4 GHz band.

Keystone Correction — Device that will correct an image of the distortion (usually a wide-top narrow-bottom effect) of a projected image caused by improper projector to screen angle.

Maximum Distance — The distance from a screen the projector can be to cast an image that is usable (bright enough) in a fully darkened room.

Maximum Image Size — The largest image a projector can throw in a darkened room. This is usually limited by focal range of the optics.

Minimum Distance — The closest position that a projector can focus an image onto a screen.

NTSC — National Television Standards Committee. North American standard for video and broadcasting, with a video format of 525 lines at 30 frames per second.

PAL — Phase Alternating Line. A European broadcast standard for video and broadcasting, with a video format of 625 lines at 25 frames per second.

Reverse Image — Feature that allows you to flip the image horizontally. When used in a normal forward projection environment text, graphics, etc. are backwards. Reverse image is used for rear projection.

RGB — Red, Green, Blue — typically used to describe a monitor that requires separate signals for each of the three colors.

S-Video — A video transmission standard that uses a 4-pin mini-DIN connector to send video information on two signal wires called luminance (brightness, Y) and chrominance (color, C). S-Video is also referred to as Y/C.

SECAM — A French and international broadcast standard for video and broadcasting, closely related to PAL but with a different method of sending color information.

SSID — Service Set Identifiers — A name used to identify the particular wireless LAN to which a user wants to connect.

SVGA — Super Video Graphics Array — 800 x 600 pixels count.

SXGA — Super Extended Graphics Array, — 1280 x 1024 pixels count.

UXGA — Ultra Extended Graphics Array — 1600 x 1200 pixels count.

VGA — Video Graphics Array — 640 x 480 pixels count.

WEP — Wired Equivalent Privacy — This is a method for encrypting communication data. The encryption key is created and notified only to the communicating user, so the communication data cannot be decrypted by a third party.

XGA — Extended Video Graphics Array — 1024 x 768 pixels count.

WXGA — Wide Extended Graphics Array — 1280 x 800 pixels count.

Zoom Lens — Lens with a variable focal length that allows operator to move the view in or out making the image smaller or larger.

Zoom Lens Ratio — Is the ratio between the smallest and largest image a lens can the project from a fixed distance. For example, a 1.4:1 zoom lens ratio means that a 10 foot image without zoom would be a 14 foot image with full zoom.

Index

A

- Adjusting the Projected Image 25
 - Elevator button 25
 - lower the projector
 - Elevator foot 25
 - Tilt adjustment wheel 25
 - Lowering the Projector Height 25
 - Raising the Projector Height 25
- Adjusting the Projector Zoom and Focus 26
 - Focus ring 26
 - Zoom tab 26

C

- Changing the Lamp 106
- Connecting the Projector
 - 12 V DC Plug 22
 - Composite Video cable 18
 - Connecting a Computer with a RS232 cable 14, 15
 - Connecting with a Component Cable 19
 - Connecting with a Composite Cable 18
 - Connecting with an HDMI Cable 20
 - Connecting with an S-video Cable 17
 - HDMI cable 20, 21, 23
 - Motorized projection screen 22
 - Power cord 12, 13, 14, 15, 17, 18, 19, 20, 21, 22, 23
 - RS232 cable 14
 - S-Video cable 17
 - To Computer 12
 - USB to USB cable 12
 - USB-A to USB-B cable 15
 - VGA to VGA cable 12, 13
 - VGA to YPbPr cable 19
- Connection Ports
 - +12 V DC out connector 10
 - Audio output connector 10
 - Audio-A input connector 10
 - Audio-B input connector 10
 - Audio-C left-channel input connector 10
 - Audio-C right channel input connector 10
 - Composite Video connector 10
 - HDMI connector 10
 - Mini USB (Mini Type B) connector for remote control 10
 - Power code connector 10
 - RJ45 connector 10
 - RS232 connector 10
 - Security cable slot 10
 - S-Video connector 10
 - USB Type A connector for USB Viewer 10
 - USB Type B connector for USB

- Display 10
- VGA-A input (D-sub) connector 10
- VGA-A output (monitor loop-through) 10
- VGA-B input (D-sub) connector 10
- WiFi USB Type A connector 10

Contact Dell 7, 104, 106

Control Panel 31

D

Dell
contacting 115

M

Main Unit 8

- Control panel 8
- Elevator button for height adjustments 8
- Focus tab 8
- IR receivers 8
- Lens 8
- Lens cap 8
- Zoom tab 8

O

On-Screen Display 38

- ADVANCED SETTINGS 41
- AUDIO INPUT 41
- AUTO ADJUST 39
- BRIGHTNESS/CONTRAST 40
- HELP 56

- INPUT SOURCE 38
- INPUT SOURCE MULTIPLE DISPLAY 39
- LANGUAGE 56
- VIDEO MODE 40
- VOLUME 41

P

phone numbers 115

Powering On/Off the Projector

- Powering Off the Projector 24
- Powering On the Projector 24

R

Remote Control 33

- IR receiver 32

S

Specifications

- Audio 109
- Brightness 108
- Color Wheel Speed 108
- Contrast Ratio 108
- Dimensions 109
- Displayable Color 108
- Environmental 109
- I/O Connectors 109
- Light Valve 108
- Noise Level 109
- Number of Pixels 108
- Power Consumption 109
- Power Supply 108
- Projection Distance 108

- Projection Lens 108
- Projection Screen Size 108
- RS232 Protocol 112
- Uniformity 108
- Video Compatibility 108
- Weight 109

support

- contacting Dell 115

T

- telephone numbers 115

Troubleshooting 101

- Contact Dell 101

V

VGA-B input (D-sub) connector
10